

5TH EDITION



AGRIPARTS  
& REPAIRS

# AGRIPARTS

AGRICULTURAL INDUSTRIAL MINING SUPPLIES



## WELCOME TO AGRIPARTS & REPAIRS NEW COMPONENTS CATALOGUE.

THERE HAVE BEEN MANY CHANGES SINCE THE LAST AGRIPARTS CATALOGUE;  
THE MAIN AND MOST SIGNIFICANT CHANGE BEING THE RELOCATION OF  
AGRIPARTS TO 29 WELSHPOOL ROAD, WELSHPOOL WA.



THERE ARE ALSO SIGNIFICANT CHANGES TO THE BUSINESS STRUCTURE IN 2017,  
WITH THE DEVELOPMENT OF THE COMPANY AGRICULTURAL, INDUSTRIAL MINING GROUP PTY LTD  
(AIM GROUP) THAT IS THE PARENT COMPANY TO FOUR DIVISIONS - AGRIPARTS & REPAIRS, MDS,  
TRANSMISSION GROUP AND FORWARD FARMING.



### AUSTRALIAN DISTRIBUTOR FOR



### MAIN PARTNERS



FOR ALL ENQUIRIES PLEASE CONTACT P: 08 9362 6811 F: 08 9361 3263  
29 WELSHPOOL RD, WELSHPOOL WA 6106, WESTERN AUSTRALIA PO BOX 232 CLOVERDALE WA 6985  
Email: sales@agriparts.com.au

PRODUCTS AND PRICES ARE SUBJECT TO CHANGE WITHOUT NOTICE



# CONTENTS

## TILLAGE EQUIPMENT

iTill® - INTELLIGENT TILLAGE	2
STILETTO SEEDING SYSTEMS <b>NEW!</b>	5
C SHANK SEEDERS	14
DBS SEEDERS	20
SINGLE BOLT SEEDERS	21
SEEDING POINTS	
Agmaster	22
Agpoint	22
16mm KNIFE POINTS	23
SINGLE SYSTEM PRESS WHEEL	24
PRESSWHEELS	25
TRIPLE / 5 GANG SYSTEM	26
COULTERS	27
SEED BRAKES <b>NEW!</b>	29
AIRSEEDER HEADS / RISER (RAYCOL)	30
TYRESHIELD	31
SUPA VEYAS	32
AIRSEEDER REPLACEMENT CONVEYOR BELTS	33
AIRSEEDER HEAVY DUTY FLEXIBLE COUPLING	33
AIRSEEDER HOSE	34
SPARE PARTS	
Bourgault	35
Case Concord	35
Chamberlain	35
Ezee-On	36
Flexicoil	36
Grizzly	36
Forward Engineers	37
Jet Stream	38
John Deere/ Conserva Pak	39
Morris	40
Simplicity	40

## LIQUID TRANSFER EQUIPMENT

LIQUID EQUIPMENT	41
A-i70	42
A-i120	42
G22 MODULE	43
SPIKER MODULE	43
AIRTOOL MANIFOLD CONFIGURATIONS	44
LIQUID SYSTEMS SPARES	47
HYPRO FLOW CONTROL	54
LIQUID SYSTEMS RATE TABLE	54
CHEMICAL TRANSFER SOLUTIONS	55
HYDRAULIC TRANSFER PUMPS	56

## FIRE AND PROTECTION EQUIPMENT

PUMPING EQUIPMENT	57
COMPACT FIRE FIGHTING UNITS	59
DAVEY REMOTE START FIREFIGHTER	63
PUMPING SPARES	64
ACCUFIRE FIRE UNITS	66
ELIDE FIRE EXTINGUISHING BALL <b>NEW!</b>	67
HOUSEHOLD PUMPS	68
WATER DISINFECTION <b>NEW!</b>	69

## HAY EQUIPMENT

DELMHORST MOISTURE METERS	71
DELMHORST MOISTURE METERS SPARES	72
TAPEX TWINE - SISAL	74
NET WRAP - RONDOTEX™	75
GRAIN STORAGE - GRAINFLEX	76
GRAIN BAGGING	77
BALER CHAINS	78
SERVICE EXCHANGE GEARBOXES	80
HAY FORKS	80
SPARE PARTS	
Sitrex	81
Teague	81
Vicon	81
Wilkinson	81

## HARVEST EQUIPMENT

DRAPER FRONT BELTING	82
PICKUP BELTS	86
SPARE PARTS	
De Engineers	87
Moylan	87

## HYDRAULIC EQUIPMENT

TIPPER TRAILER KITS <b>NEW!</b>	88
TIPPER INSTALLATION KITS <b>NEW!</b>	90
HYDRAULIC POWER UNITS <b>NEW!</b>	91
HOSE ASSEMBLY KITS	91
HYDRAULIC MOTORS	91
HYDRAULICS COUPLER / MOTORS	93
COUPLINGS	93
HYDRAULIC CYLINDERS	94
SPIRALGUARD	95

## POWER TRANSMISSION EQUIPMENT

CLUTCHES	96
PTO SHAFTS	97
GEARBOXES	98
SIMOL JACKS	99

## WORKSHOP EQUIPMENT

PRESSURE CLEANERS	101
GENERATORS	102
YAMAHA ACCESSORIES	102
GENERATORS	103
AIR COMPRESSORS	104
WESTAIR PORTABLE AIR COMPRESSORS	106
AIRSTREAM PORTABLE AIR COMPRESSORS	107
WELDERS	108

## ELECTRICAL EQUIPMENT

WINCHES	111
SNATCH STRAPS	112
LED WORKLIGHTS	113
CAMERA KITS	114
MOBILE SMART PHONE CAR KITS	115

## MISCELLANEOUS TRACTOR PARTS

CHAMBERLAIN	116
-------------	-----

SERVICE	117
---------	-----

PRODUCTS AND PRICES ARE SUBJECT TO CHANGE WITHOUT NOTICE

T: (08) 9362 6811

1

F: (08) 9361 3263



# iTILL® - INTELLIGENT TILLAGE

Introducing iTILL PRO - WiFi enabled implement steering - New for 2017.

## The New iTILL PRO:

iTiLL Pro now has wireless finger tip control right from the palm of your hand. Use any smart device, be it tablet or phone to control your implement guidance right from the tractor seat or in a vehicle driving along side the seeder on the go!

iTiLL Pro now offers the next level in implement guidance totally independent to the tractors auto steer system accurately guiding the seeder either right down the previous years row or anywhere in between depending on moisture and stubble handling requirements.

If you want to be able to steer your seeder bar either on the row to utilise residual moisture or down the inter row to avoid stubble blockages - iTiLL is the only choice.

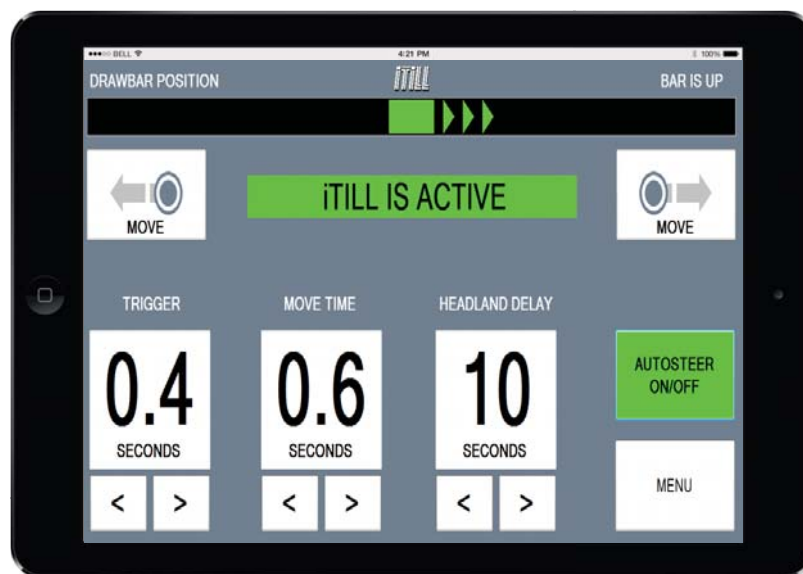

## SMARTS:

### Works the way you do...

iTiLL Pro is the only system that integrates seamlessly into the existing hydraulic system of your tractor taking over control of the required hydraulic functions as if you were controlling them with your own hand. iTiLL senses when you have begun a new pass and wont activate the system until the tractor and seeder are straight. When iTiLL is active you can set the limits as to how far you want the drawbar to steer left or right. If the drawbar is approaching its limits the system will alert you. At the end of the run, the system will centre the drawbar ready for the next run. Multiple row sensors can be run simultaneously where stubble rows have been flattered due to wheel marks from spraying or harvest operations giving 20 mm repeatability year after year..

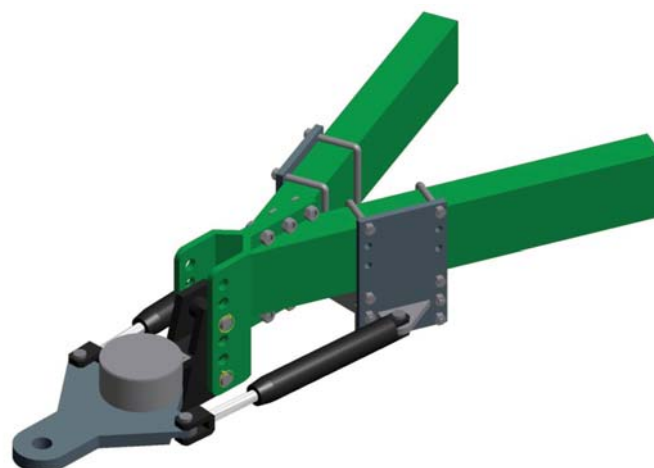

PRICES EXCLUDE GST

T: (08) 9362 6811

2

F: (08) 9361 3263



# iTILL® - INTELLIGENT TILLAGE

## Keeps your row straight

iTILL allows you to fully customise the sensitivity of the steering. The proprietary software monitors the sensor input and depending on the frequency only adjusting the steering position when required to. This significantly reduces the wear and tear on the hydraulic and steering components on your tractor and seeder.

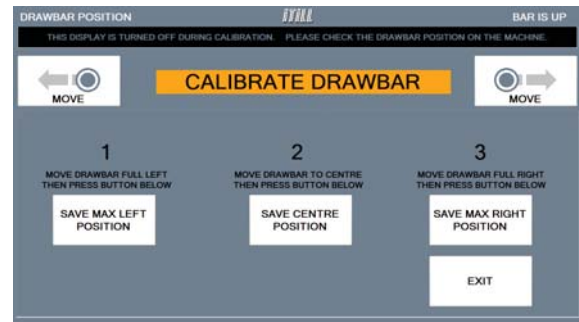

## Awards:

Since its inception in 2012, iTILL has set the standard in the industry receiving a number of awards including best new release, best commercial innovation and best farmer innovation at the 2012 Newdegate Machinery Field Day.

## Research:

A 5 year GRDC initiative in collaboration with CSIRO looking at water infiltration and crop performance when sown on - row verse sowing on the inter - row has used iTILL to provide implement guidance throughout the project.



ITILLCONTR



ITILLCPU



ITILLHARTR



ITILLHAR20



ITILLHAR10



Left - sown on the inter row  
Right-sown on the row using iTILL Pro



PRICES EXCLUDE GST

T: (08) 9362 6811

3

F: (08) 9361 3263



# iTILL® - INTELLIGENT TILLAGE

## DRAWBAR KITS AVAILABLE FOR STEERING IN ROW OR BETWEEN

### DRAWBAR KIT INCLUDE;

- In Cab Control Module, Camera & wiring looms
- New Hitch to integrate into existing
- Hydraulic rams & hose kit
- All plates and u-bolts to attach to steerable

ORDER NO	DESCRIPTION
OPTIONS	
ITILLHAR10	WIRING HARNESS EXTENSION 10M
ITILLHAR15	WIRING HARNESS EXTENSION 15M
ITILLHAR20	WIRING HARNESS EXTENSION 20M
	HYDRAULIC DIVERTOR VALVE KIT



ORDER NO	MODEL	TYRE SPACING (INCHES)	SUITS
<b>DBS AUSEEDER</b>			
ITILLDBSD260	D260	10	D260-24, D260-32, D260-36, D260-42, D260-48E, D260-54, D260-59
ITILLDBSD300	D300	12	D300-32, D300-36, D300-40, D300-44, D300-46, D300-51, D300-55
ITILLDBSD381	D381	15	D381-28, D381-32, D381-36, D381-40, D381-44, D381-48
<b>BOURGAULT</b>			
ITILLBOU5710	5710	9.8 & 12.6	5710-40, 5710-50
*UPON ORDERING PLEASE SPECIFY TRACTOR BRAND*			

PRICES EXCLUDE GST

# STILETTO SEEDING SYSTEMS

## BENEFITS

Since conception in 2004 with limited release until 2006 when it was made commercially available, Stiletto has earned its exceptional reputation through its unique design.

Providing customers with optimised efficiency and usability, Stiletto is the only closed seeding system designed and suited to Australian conditions.



### Closed Seeding System

Stiletto's closed seeding system provides customers with the highest standard of seed quality than other seeding systems on the market today. Its unique design optimises germination conditions, protecting the seed from risks such as chemical contamination and mouse holing. Join the Stiletto customers who are experiencing higher yields and lower 'in field' costs.

### Speed

Experience both speed and control with Stiletto's unique design which allows you to work through the day without interruption. Its specially designed point offers greater sowing speeds and decreased risk of chemical damage leading to higher yield potential.

### Better Row Competition

Benefit from the reduction of late germination volunteer weeds, like ryegrass. Stiletto's three and four inch split allows seedlings to compete better within the row.

### Chemical Damage

Unlike competitors Stiletto's design promotes even rates of crop growth, whereby the seed is placed under the ground with clean soil on top so the seed is rarely exposed to the elements thus almost eliminating the chance of chemical contamination on all tynes even if Triflurilan is thrown into the row.

### Strength And Durability

Our product is one of the strongest on the market our points are drop forged for superior strength and durability and backed up with a 10mm x 50mm tungsten tile and super durable tungsten grit. The wings and fertiliser adapters are cast using only the best mix of alloys for strength and durability.

PRICES EXCLUDE GST

T: (08) 9362 6811

5

F: (08) 9361 3263

# STILETTO SEEDING SYSTEMS

## HOW IT WORKS

**THE STILETTO SEEDING SYSTEM** is split into three components each having their own affect on achieving the best placement possible. The Point, the Adapter and the Wing. Starting with the 35 degree entry angle and uniquely designed taper in all of our points, it manipulates the flow of soil, creating a more consistent throw pattern and better incorporation of the added chemicals such as Triflurilan and Boxer Gold.

The fertiliser adapter is designed to place the fertiliser approximately an inch below the seed, then as the wing follows through it closes the slot left open by the point and fertiliser adapter.

The wing places the seed, using the bedformers on it's underside, effectively sandwiching the seed and almost eliminating chemical damage caused by affected soil landing in the row.

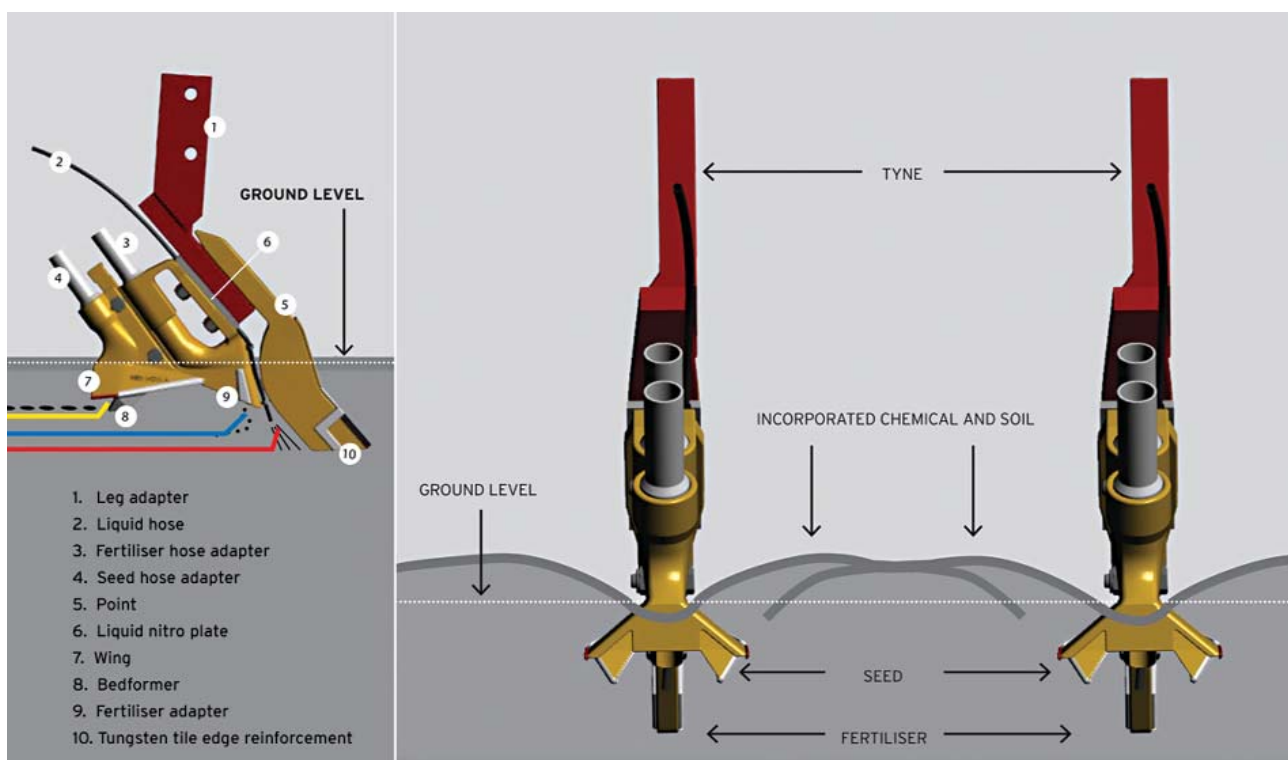

PRICES EXCLUDE GST





T: (08) 9362 6811





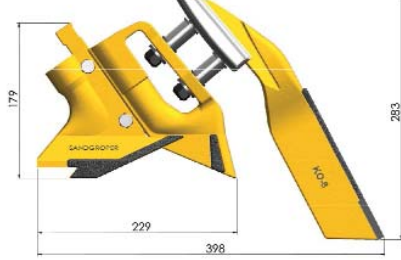









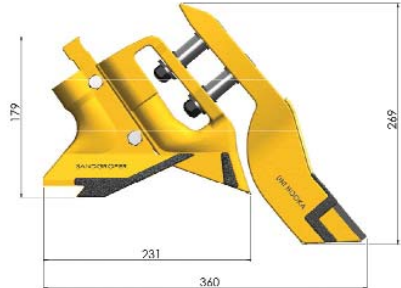

6

F: (08) 9361 3263









# STILETTO SEEDING SYSTEMS

KNOCK ON SYSTEM <b>SYS KO</b>	DIMENSIONS	MAIN FEATURES
	   	<p>The <b>KNOCK ON SYSTEM</b> combines our Knock on Point and mount, stiletto wing and fertiliser adapter. Farmers are able to customise this system by mixing and matching any of the Stiletto wings.</p> <p>Designed for use with curved point mount (Flexi-Coil, Morris and John Deere).</p> <p><b>The KO-8 System contains</b></p> <ul style="list-style-type: none"> <li>1 x Knock on mount</li> <li>1 x Knock on point</li> <li>2 x Bolts for mounting to tyne</li> <li>2 x Bolts for mounting wing</li> <li>1 X STD Fertiliser adapter</li> <li>1 x Sowing wing</li> <li>4 x Cone lock nuts (2 big &amp; 2 small)</li> <li>2 x Serrated washer</li> </ul> <p><b>Options</b></p> <ul style="list-style-type: none"> <li>Liquid Nitro Plate</li> <li>Hose adapters</li> <li>Concorde leg adapter</li> <li>Contour drill leg adapter</li> </ul> <p><b>Point choice</b></p> <p>KO-8</p> <p><b>Wing Choice</b></p> <p>SANDGROPER 3 or REDDOG 3 or REDDOG 4</p>

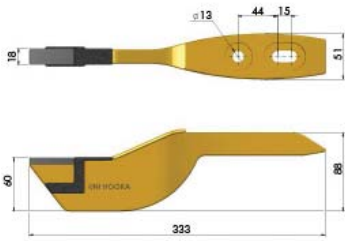
RATTLE ON SYSTEM <b>SYS RO</b>	DIMENSIONS	MAIN FEATURES
  <p><b>RED DOG 3</b></p>     	  <p><b>RED DOG 4</b></p>     	<p>The <b>RATTLE ON SYSTEM</b> combines a rattle on point, stiletto wing and fertiliser adapter. Farmers are able to customise this system by mixing and matching any of the Stiletto wings with any one of our rattle on points.</p> <p>Designed for use with curved or flat point mount (Flexi-Coil, Morris, John Deere, Borgault, Gason and Horwood Bagshaw).</p> <p><b>The RO-7 System contains</b></p> <ul style="list-style-type: none"> <li>1 x Point</li> <li>2 x Bolts for mounting to tyne</li> <li>2 x Bolts for mounting wing</li> <li>1 x Fertiliser adapter</li> <li>1 x Sowing wing</li> <li>2 x Cone lock nuts</li> <li>2 x Serrated washer</li> </ul> <p><b>Options</b></p> <ul style="list-style-type: none"> <li>Liquid Nitro Plate</li> <li>Hose adapters</li> <li>Concorde leg adapter</li> <li>Contour drill leg adapter</li> </ul> <p><b>Point choice</b></p> <p>UNI or STD, 35 or HOOKA</p> <p><b>Wing Choice</b></p> <p>SANDGROPER 3 or REDDOG 3 or REDDOG 4</p> <p><b>SANDGROPER 3</b></p>     



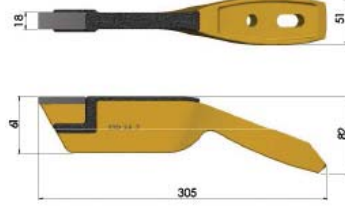

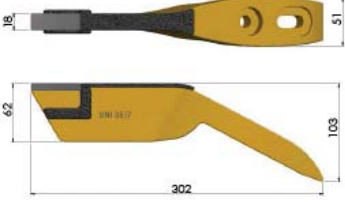

PRICES EXCLUDE GST

# STILETTO SEEDING SYSTEMS

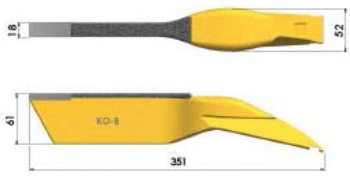
UNI HOOKA UNIHOOKA	DIMENSIONS	MAIN FEATURES
		<p>Our unique point that combines the easy pulling of a 45° point and the reduced throw of a 35° point together with the tapered mount results in even better trash clearance (especially in couch or similar grasses) and a more precise throw of soil in the use of chemicals such as Triflurilan / Boxer Gold.</p> <ul style="list-style-type: none"> <li>• Unrivalled trash clearance with its smooth lines and unique chamfer on top to prevent snagging.</li> <li>• Recommended for 350lb (still ok with 550lb)</li> <li>• Break out machines.</li> <li>• 10 x 16 x 50 mm recessed tungsten carbide tile, backed up with overlay tungsten.</li> <li>• Fast replacement (rattle on and off).</li> <li>• Fits flat mount tyne machines such as Bourgault, Gason and Horwood Bagshaw.</li> </ul>
<p>STANDARD HOOKA STDHOOKA</p> 	<p>DIMENSIONS</p> 	<p>Our unique point that combines the easy pulling of a 45° point and the reduced throw of a 35° point together with the tapered mount results in even better trash clearance (especially in couch or similar grasses) and a more precise throw of soil in the use of chemicals such as Triflurilan / Boxer Gold.</p> <ul style="list-style-type: none"> <li>• Unrivalled trash clearance with its smooth lines and unique chamfer on top to prevent snagging.</li> <li>• Recommended for 350lb (still ok with 550lb) break out machines.</li> <li>• 10 x 16 x 50 mm recessed tungsten carbide tile, backed up with overlay tungsten.</li> <li>• Fast replacement (rattle on and off).</li> <li>• Fits all curved tyne bars - John Deere, Morris and Flexi-Coil.</li> </ul>
<p>STD RATTLE ON POINT STD 357</p> 	<p>DIMENSIONS</p> 	<p>The combination of 35° entry angle and tapered mount results in a more precise throw of soil in the use of chemicals such as triflurilan / boxer gold.</p> <ul style="list-style-type: none"> <li>• Unrivalled trash clearance with its recessed bolt holes and unique chamfer on top to prevent snagging.</li> <li>• 550 and 350 lbs hole configuration.</li> <li>• 35° entry angle</li> <li>• 10 x 16 x 50 mm recessed tungsten carbide tile, backed up with overlay tungsten.</li> <li>• Fast replacement (can use rattle gun)</li> <li>• Fits all curved tyne bars (green points) - John Deere, Morris and Flexi-Coil</li> </ul>
<p>UNI RATTLE ON POINT UNI 357/6</p> 	<p>DIMENSIONS</p> 	<p>The combination of 35° entry angle and tapered mount results in a more precise throw of soil in the use of chemicals such as Triflurilan / Boxer Gold.</p> <ul style="list-style-type: none"> <li>• Unrivalled trash clearance with its recessed bolt holes and unique chamfer on top to prevent snagging.</li> <li>• 550 and 350 lbs hole configuration.</li> <li>• 35° entry angle</li> <li>• 10 x 16 x 50 mm recessed tungsten carbide tile, backed up with overlay tungsten.</li> <li>• Fast replacement (can use rattle gun)</li> <li>• Fits all flat tyne bars Borgault, Gason and Horwood Bagshaw</li> </ul> <p>Also comes as 356 with 275mm length.</p>

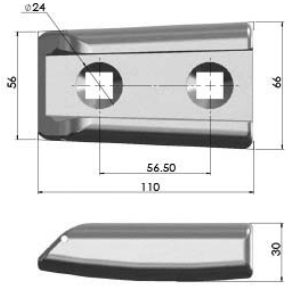
PRICES EXCLUDE GST

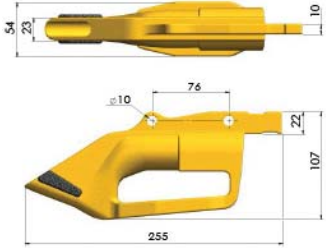
# STILETTO SEEDING SYSTEMS

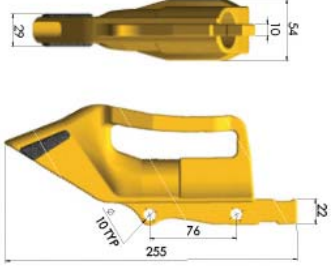
KNOCK ON POINT <b>KO 8</b>	DIMENSIONS	MAIN FEATURES
		<p>The Knock On Point is aimed at the farmer that wants a fast way of replacing their points. It is as simple as sliding the point into the adapter and inserting a safety pin to prevent the point being dislodged when the tyne recoils abruptly.</p> <ul style="list-style-type: none"> <li>• Unrivalled trash clearance with its smooth lines and unique chamfer on top to prevent snagging.</li> <li>• 45 degree entry angle for easier pull in tough conditions.</li> <li>• 8 x 18 x 50 mm tungsten carbide tile, backed up with overlay tungsten.</li> <li>• Fast replacement (pull pin knock out and slide new point in).</li> <li>• Fits all curved tyne bars - John Deere, Morris and Flexi-Coil.</li> </ul>
		<p>The Knock On Mount is the mounting unit for the Knock On 8 to suit 350 lbs (or 550 lbs) break out hole configuration.</p>
		<p>The Stiletto adapters are designed to hold the sowing wing and place the fertiliser. Each of the adapters have been engineered to maintain the wing level as it travels under the ground depending on the bar it is set up on.</p> <p>Designed for use with flat tyne bars (Borgault, Gason and Horwood Bagshaw).</p>
		<p>The Stiletto adapters are designed to hold the sowing wing and place the fertiliser. Each of the adapters have been engineered to maintain the wing level as it travels under the ground depending on the bar it is set up on.</p> <p>Designed for use with curved tyne bars (John Deere 1830, Morris and Flexi-Coil).</p>

PRICES EXCLUDE GST







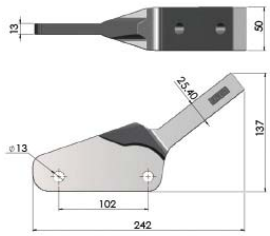

# STILETTO SEEDING SYSTEMS

SEEDING WING SANDGROPER 3	DIMENSIONS	MAIN FEATURES
		<p>Designed for non-wetting soils ranging up to medium to heavy clay. The sloped leading edge of the wing closes the slot left by the point and creates a firm bed for the seed to be placed on. The extended bridge across the back of the wing reduces seed bounce, keeping the seed split at <b>3 inches</b> wide. This makes it the benchmark in wing seeding systems. Used in conjunction with the fertilizer adapter it can also be used in a single shoot system to place seed and fertiliser together.</p> <p><b>Suitable for sandy soils.</b></p>
		<p>Designed for use in heavy clay. The flatter underside of the wing allows better flow of clay soil while in conjunction with bedformers it creates a firm bed for seed to be placed and split at <b>3 inches</b> wide whilst still effectively closing the slot made by the point.</p> <p>Used in conjunction with the fertilizer adapter. Can also be used in single shoot system to place seed and fertiliser together.</p> <p><b>Suitable for clay soils.</b></p>
		<p>Designed for use in heavy clay. The flatter underside of the wing allows better flow of clay soil while in conjunction with bedformers it creates a firm bed for seed to be placed and split at <b>4 inches</b> wide, whilst still effectively closing the slot made by the point.</p> <p>Used in conjunction with the fertilizer adapter. Can also be used in single shoot system to place seed and fertiliser together.</p> <p><b>Suitable for clay soils.</b></p>
		<p>Stiletto Para Boot to fit the DBS and Stiletto Para Boot to fit PSS (Primary Sales Seeder).</p> <p>Advantages are all the usual Stiletto things like better seed placement and germination also the fact that there is no loss of seed to the bottom of the furrow due to the mouse holing effect caused by the standard seed closer plate.</p> <p>Better yields are achieved, because the seed is sown into uncultivated soil the seed is sitting in moisture and not where the point has dried out the soil.</p> <p>Also it has the ability to chase moisture.</p>

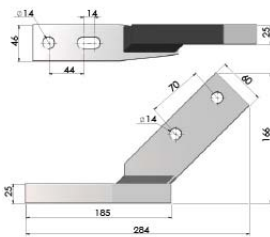
PRICES EXCLUDE GST

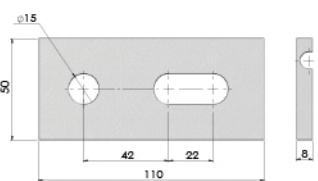
# STILETTO SEEDING SYSTEMS

DRILL MOUND ADAPTER <b>MCDA</b>	DIMENSIONS	MAIN FEATURES
		<p>The MCDA allows you to fit the Stiletto Seeding System to the Morris Contour drill.</p>
		<p>The MCSA allows you to fit the Stiletto Seeding System to the Concord Air Hoe Drill.</p>
		<p>Liquid Nitrogen plate fits in front of the fertiliser adapter allowing the farmer to band flexi-N and other liquid products behind the knife point.</p>
		<p>Adapter to Fit 25mm (or 32mm) ID hose.</p>

PRICES EXCLUDE GST

# STILETTO SEEDING SYSTEMS

OTHER PARTS		
BOLTS	NUTS	WASHERS
 <p><b>G8 HEX HEAD BOLT 1/2" X 3"UNC</b> Use for 25mm Tyne      Part Number: B1</p> <p><b>G8 HEX HEAD BOLT 1/2" X 3 1/4"UNC</b> Use for 25MM With Liquid Plate or 32mm Tyne Part Number: B2</p> <p><b>G8 HEX HEAD BOLT 1/2" X 3 1/2"UNC</b> Use for 32MM Tyne with Liquid Plate B3 Part Number: B3</p> <p><b>G8 HEX HEAD BOLT 3/8" X 1/2" UNC</b> Attach Wing &amp; Adaptor Together Part Number: B4</p> <p><b>COUNTERSUNK BOLT 1/2" X 3"</b> Knock-On Knife Points      Part Number: B5</p>	 <p><b>CONE LOCK NUT 1/2"</b> Use for all Knife Points Part Number: N1</p> <p><b>CONE LOCK NUT 3/8"</b> Part Number: N1</p>	 <p><b>WASHER SERATED LOCK 1/2"</b> Use for all Knife Points      Part Number: W1</p> <p><b>WASHER SPRING 1/2"</b>      Part Number: W2</p> <p><b>WASHER FLAT 1/2"</b>      Part Number: W3</p>



PRICES EXCLUDE GST





# STILETTO SEEDING SYSTEMS

PART NO	DESCRIPTION	USE	PRICE
WING SANDGROPER 3	3" SEEDER WING SPLITTER	SANDY SOILS	\$105
WING REDDOG 3	3" SEEDER WING SPLITTER	CLAY SOILS	\$105
WING REDDOG 4	4" SEEDER WING SPLITTER	CLAY SOILS	\$105
PARAWING DBS	4" SEEDER WING WITH 550MM STAINLESS STEEL TUBE	DBS TYNE	\$150
PARAWING PSS			\$195

HA-25	HOSE ADAPTER REDUCED	TO FIT 25MM HOSE	\$5
HA-32	HOSE ADAPTER STRAIGHT	TO FIT 32MM HOSE	\$5

ADP UNI	FERTILISER ADAPTER UNIVERSAL	TO FIT FLAT TYNE	\$60
ADP JD	FERTILISER ADAPTER JD	TO FIT JD 1820 TYNE	\$60
ADP FC	FERTILISER ADAPTER FC	TO FIT JD 1830 & OTHER CURVED TYNES	\$60
MCDA	MORRIS CI SHANK ADAPTER	MORRIS CONTOUR SHANK	\$80
MCSA	CONCORD SHANK ADAPTER		\$80

STD357	KNIFE POINT	18MM X 7" STANDARD RATTLE ON WITH TILE & TUNGSTEN COATING	\$85
UNI357/6	KNIFE POINT	18MM X 7" UNIVERSAL RATTLE ON WITH TILE & TUNGSTEN COATING	\$85
STDHOOKA	KNIFE POINT	18MM X 7" HOOKA STANDARD RATTLE ON WITH TILE & TUNGSTEN COATING	\$85
UNIHOOKA	KNIFE POINT	18MM X 7" HOOKA UNI RATTLE ON WITH TILE & TUNGSTEN COATING	\$85
KO-8	KNIFE POINT	18MM X 8" KNOCK ON 8"	\$65
KOM 350	KNIFE POINT MOUNT FOR KNOCK ON 8"	350 BREAKOUT	\$15
KOM 550	KNIFE POINT MOUNT FOR KNOCK ON 8"	550 BREAKOUT	\$15
SPACERS	LIQUID NITRO PLATE WITH 6MM POLY TUBE		\$15

SYS KO	INCLUDES A SEEDER WING, HOSE ADAPTER, ADAPTER & KNOCK ON KNIFE POINT & MOUNT		\$245
SYS RO	INCLUDES A SEEDER WING, HOSE ADAPTER, ADAPTER & RATTLE ON KNIFE POINT		\$250

**ALL SYSTEMS INCLUDE CONE LOCK NUTS, LOCK WASHERS AND BOLTS TO FIT KNIFE POINTS  
ALL WING ADAPTERS COME WITH GRADE 8 BOLTS AND LOCK NUTS TO FIT THEM TOGETHER**

B1	G8 HEX HEAD BOLT - 1/2" X 3" UNC	25MM TYNE	\$1.00
B2	G8 HEX HEAD BOLT - 1/2" X 3 1/4" UNC	25MM TYNE WITH LIQUID PLATE OR 32MM TYNE	\$1.00
B3	G8 HEX HEAD BOLT - 1/2" X 3 1/2" UNC	32MM TYNE WITH LIQUID PLATE	\$1.20
B4	G8 HEX HEAD BOLT - 3/8" X 1 1/2" UNC	ATTACH WING & ADAPTER TOGETHER	\$0.30
B5	CONTERSUNK BOLT 1/2" X 3"	KNOCK ON KNIFE POINTS	\$2.00
N1	CONE LOCK NUT 1/2"	ALL KNIFE POINTS	\$0.60
N2	CONE LOCK NUT 3/8"	ATTACH WING & ADAPTER TOGETHER	\$0.20
W1	WASHER SEPARATED LOCK 1/2"	ALL KNIFE POINTS	\$1.00
W2	WASHER SPRING 1/2"		\$0.20
W3	WASHER FLAT 1/2"		\$0.50
PT6	6MM X 400MM BLACK POLY TUBE	LIQUID PLATES	\$1.00

PRICES EXCLUDE GST

**T: (08) 9362 6811**

**13**

**F: (08) 9361 3263**

# C SHANK SEEDERS

POINT BOOT KITS		MAIN FEATURES	PRICE
PB-1000		SLOT MATE KNIFE POINT AND SINGLE SHOOT FIXED BOOT	\$145
PB-1100		SLOT MATE KNIFE POINT AND SINGLE SHOOT SPLIT BOOT	\$153
PB-1200		SLOT MATE KNIFE POINT AND SINGLE SHOOT FLEXI BOOT	\$157
PB-2000		SLOT MATE KNIFE POINT AND DOUBLE SHOOT FIXED BOOT	\$163
PB-2100		SLOT MATE KNIFE POINT AND DOUBLE SHOOT SPLIT BOOT	\$171
PB-2200		SLOT MATE KNIFE POINT AND DOUBLE SHOOT FLEXI BOOT	\$175





All Points and Boot Kits include:

- Boot Kit
- Slot Mate Knife Point
- Slot Mate Adapter
- 2 x 2 3/4 x 1/2 Gr. 8 Hex Bolt/Nut
- Lynch Pin
- All other Bolts & Nuts to suit

When ordering a Point Boot Kit please specify machine or tyne/shank.

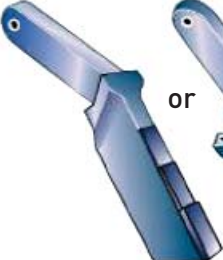
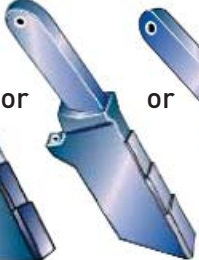
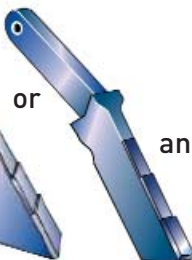
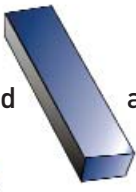
Maxipoint Seed Boots can fit the below shank tynes:

- **C-Shank (standard)**
- **Simplicity**
- **Horwood Straight/Curved**
- **Gason**
- **Flexicoil Edge On**
- **And more.**



<b>SMV</b>	<b>SMS</b>	<b>SMD</b>	<b>12 or 15mm Wide</b>	<b>Choice of 7/16 or 1/2</b>	<b>SMF</b>	<b>Trash Guard</b>	<b>SLL</b>
	or 	or 	and 	and 			
INCLUDED	INCLUDED	INCLUDED	INCLUDED	INCLUDED	Add \$6.00	Add \$24.00	Add \$20.00

PRICES EXCLUDE GST

# C SHANK SEEDERS

BOOT KITS		
	MAIN FEATURES	PRICE
SB-1230 	SINGLE SHOOT FIXED	\$92.00
SB-1232 	SINGLE SHOOT SPLIT	\$100.00
SB-1234 	SINGLE SHOOT FLEXI	\$104.00
DB-1220 	DOUBLE SHOOT FIXED	\$110.00
DB-1222 	DOUBLE SHOOT SPLIT	\$118.00
DB-1224 	DOUBLE SHOOT FLEXI	\$122.00

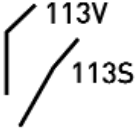

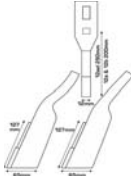



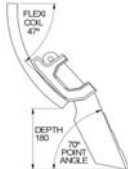

Bolts and fasteners included with all boot kits. For SB-1232 & DB-1222 specify 40mm or 70mm split backshoot.

EZI BLADE KNIFE POINTS			
PART NO	DIMENSIONS	FEATURES	PRICE
PT-113V VERTICAL  PT-113S STRAIGHT	<b>BLADE ANGLES</b> 	The Ezi Blade is available in two styles: one with a more vertical angle for less soil throw and one with a straighter angle for increased soil throw and easier pulling.	\$54.50
DYNA BLADE KNIFE POINTS			
PT-112A CURVED  PT-112B FLAT		The Dyna Blade is available in two styles: one for flat tynes and one for curved tynes. A no till point made from forged steel for unparalleled strength and wear resistance.	\$60.10

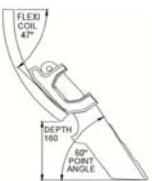
PRICES EXCLUDE GST

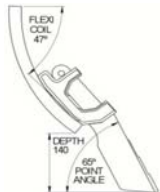

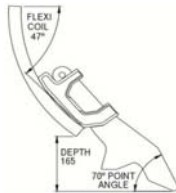
# C SHANK SEEDERS

SLOT MATE KNIFE POINTS			
PART NO	DIMENSIONS	FEATURES	PRICE
<b>SLOT MATE 'V'</b> PT-1SMV - 12MM PT-1SMV5 - 15MM PT1SMV8 - SLL	 	Maxipoint's best selling point, Proven technology, Made in Australia. Point angle minimizes soil throw. Made from ultra long life toughened steel and won't crack under shock loads.	\$51.80 \$55.80 \$75.80
<b>SLOT MATE 'S'</b> PT-1SMS - 12MM PT-1SMS5 - 15MM PT1SMS8 - SLL	 	Made from ultra long life toughened steel. Hard and resilient, won't crack under shock loads. Hole can be drilled at rear as optional upgrade (specify size). 60° angle equals less pulling power required. More soil throw than the Slot Mate V.	\$52.80 \$56.80 \$76.80
<b>SLOT MATE 'D'</b> PT-1SMD	 	Similar point to the bolt on Dyna Blade. Allows farmers to change from deep tillage to shallow tillage without undoing any bolts. Used commonly with farmers not wanting to dig up rocks resting deeper beneath the the soil.	\$53.60
<b>SLOT MATE 'F'</b> PT-1SMF12	 	Inverted T design to increase soil disturbance. Tungsten tiles on leading edge and underside of the wing. Hardfacing on the wings and sides as standard. Two Tungsten width options, 9mm or 12mm. Comes painted as standard.	\$68.60
<b>SLOT MATE 'E'</b> PT-SMEA		Adapter to accommodate Points of the Ezi Fit system.	\$17.20
<b>TRASH GUARD</b> PT-2002		Trash Guard <ul style="list-style-type: none"> <li>• Trash Guard to fit around the Slot Mate adapter.</li> <li>• Slot Mate points still able to be quickly removed or inserted with guard fitted.</li> <li>• Adapter not included in price.</li> </ul>	\$24.00





PRICES EXCLUDE GST



# C SHANK SEEDERS

SLOT MATE KNIFE POINTS		
PART NO	FEATURES	PRICE
<b>SLOT MATE ADAPTER</b> PT-1SMA1/2 1/2" PT-1SMA7/16 7/16" 	Proven Slot Mate system adaptor. Available in 1/2" and 7/16" bolt hole sizes. Maxipoint now stocks a full range of fasteners, check out our fasteners guide for more information. <ul style="list-style-type: none"> <li>• Adapter to suit 1/2" Bolt Tynes.</li> <li>• Adapter to suit 7/16" Bolt Tynes.</li> </ul>	\$9.00
<b>SLOT MATE SWEEP</b> PT-2020 4" PT-2021 6" PT-2022 8" PT-2023 10" PT-2024 12" 	<ul style="list-style-type: none"> <li>• Slot Mate quick change sweep system.</li> </ul>	\$21.00 \$24.00 \$29.00 \$33.00 \$37.00
EZIFIT SYSTEM		
<b>EZI RIPPER</b> PT-10ER 	Made from NiHard which has a hardness rating of 600 Brinell which results in high wear resistance. Hollow back section of the point is designed to fit the Maxipoint adapter tongue and is fastened by a roll pin.	\$43.90
<b>DEEP RIPPER</b> PT-10DR 	Made from NiHard with a rating of 600 brinell for ultra long life. Tungsten tipped for ultimate blade protection. Drilled hole to allow for roll pin insertion. Designed as a deeper version of the Ezi Ripper. Longer blade for seeding at deeper depths.	\$44.20
<b>EZI SEEDER</b> PT-10ES 	Made from NiHard with a rating of 600 brinell for ultra long life. Tungsten tipped for ultimate blade protection. Drilled hole to allow for roll pin insertion.	\$48.10
<b>DEEP SEEDER</b> PT-10DS 	Made from NiHard with a rating of 600 brinell for ultra long life. Tungsten tipped for ultimate blade protection. Tungsten tile on underside of wing. Designed as a deeper seeding version of the Ezi Seeder. Longer blade for seeding at deeper depths while maintaining adequate soil throw.	\$48.80
<b>EZI TILLER</b> PT-10ET 	Made from NiHard with a rating of 600 brinell for ultra long life. Tungsten tipped for ultimate blade protection. Drilled hole to allow for roll pin insertion. 115mm wide wings for maximum tillage option while staying within the Ezi Fit system. As an optional upgrade hardfacing weld can be applied to the wings.	\$49.50



PRICES EXCLUDE GST

# C SHANK SEEDERS

BACKSHOOTS		
PART NO	FEATURES	PRICE
<b>FIXED</b> BS-1240 	<ul style="list-style-type: none"> <li>• 50mm wide closer plate with tungsten tile wear protection.</li> <li>• Adjustable angle to reduce clogging in heavy conditions.</li> </ul>	\$70.00
<b>SPLIT</b> BS-1260 40MM SPLIT 	<ul style="list-style-type: none"> <li>• 40mm or 70mm split options.</li> <li>• Adjustable angle.</li> <li>• Tungsten protected closer plate.</li> </ul>	\$79.00
BS-1262 70MM SPLIT 		\$89.00
<b>FLEXI</b> BS-1280 	<ul style="list-style-type: none"> <li>• Keeps the closer plate in the ground on lower breakout tynes.</li> <li>• 40mm closer plate.</li> </ul>	\$83.00

BACKSHOOT HOSE ADAPTERS	
SUITS 32MM SEED HOSE	
	
BS-0350	BS-0352
\$3.50	\$6.50





Can be fitted by tek-screwing or welding in. We recommend the curved adapters if using backshoots on tilted back angle.



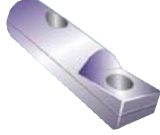
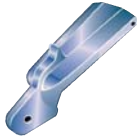

BACKSHOOT HOSE ADAPTERS	
SUITS 38MM SEED HOSE	
	
BS-0354	BS-0356
\$5.00	\$9.50

CLOSER PLATE (to weld on)	
	
BS-0243 40mm	BS-0244 50mm
\$19.00	

PRICES EXCLUDE GST

# C SHANK SEEDERS

ADAPTERS		
PART NO	FEATURES	PRICE
<b>WEDGE</b> PT-1MW1 1/2 x 45 PT-1MW2 7/16 x 45 PT-1MW3 1/2 x 57 	45mm - 57mm Hole Centre Wedges with 1/2" & 7/16" Holes.	\$15.80
<b>2 BOLT HOLE ADAPTER</b> PT-2011 	Suits two bolt tynes and single-bolt points.	\$20.00
<b>WEDGE ADAPTER</b> PT-1EWA 	Fits on most Wedges for use on two-bolt Cultivators and Chisel Plows.	\$21.60
<b>2-BOLT CURVED ADAPTER</b> PT-1E48 	Fits two-bolt Cultivators and Chisel Plows.	\$36.10
<b>CULTI ADAPTER</b> PT-1EW46 	Suits two bolt 7/16 combine tynes.	\$27.30
<b>SCARI ADAPTER</b> PT-SA 	Fits scarifier tynes. Use one 2 1/2 x 1/2 UNC B & N.	\$31.20

INLINE SERIES SEED BOOT		
PART NO	FEATURES	PRICE
<b>IS-1001</b> PAIRED ROW   Tungsten grit hard faced for long life wear protection 2 liquid fertiliser depth positions	<ul style="list-style-type: none"> <li>• Accurate seed placement</li> <li>• Heavy duty robust design</li> <li>• Liquid fertiliser ready</li> <li>• Suits 32 and 38mm hoses, and most 2 bolt cultivator tynes</li> <li>• Large seed exit holes, precision placement, no plugging</li> <li>• Deep banding fertiliser shoot, large exit hole, no blocking</li> </ul>	<b>IS-1001</b> \$165.00
<b>IS-1002</b> SIDE BANDED   	SIDE BANDED      PAIRED ROW      BACK VIEW PAIRED ROW	<b>IS-1002</b> \$115.00

PRICES EXCLUDE GST











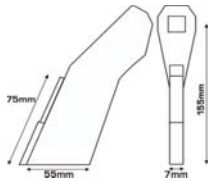

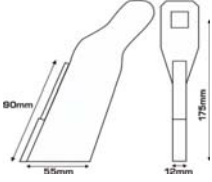
# DBS SEEDERS

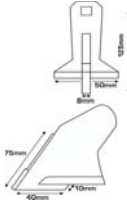
SLOT MATE A		
PART NO	FEATURES	PRICE
PT-1071 6" PT-1076 6" SLL 	This point fits the unique Slot Mate A adapter which is bolted onto the tyne and never taken off. This point has a bigger, thicker tongue to accommodate increased breakout and vertical angle tynes. Made from ultra long life toughened steel for superior strength and consistency. 6" Depth.	\$55.50 \$75.50
PT-1072 7" PT-1077 7" SLL 	Three tungsten tiles on all models for increased wear load and proven not to crack under shock loads. This point has a bigger, thicker tongue to accommodate increased breakout and vertical angle tynes. 7" Depth.	\$56.50 \$76.50
PT-1073 8" PT-1078 8" SLL 	Made from ultra long life toughened steel for superior strength and consistency. This point fits the unique Slot Mate A adapter which is bolted onto the tyne and never taken off. This point has a bigger, thicker tongue to accommodate increased breakout and vertical angle tynes. 8" Depth.	\$56.50 \$76.50
ADAPTER PT-1070 	Adapter to suit DBS type shank.	\$9.50
TRASH GUARD PT-2008 	Trash guard fits neatly around adapter, increasing trash flow around the adapter and lower tyne. Slot Mate point can still be quickly replaced when trash guard is fitted. To suit DBS type shank when Slot Mate point and adapter is fitted.	\$26.00
SLOT MATE A WINGED 6" PT-1081 7" PT-1081 8" PT-1082 	60mm wing for increased soil disturbance. Slot Mate Winged point to suit DBS applications.	\$72.80
DB RIPPER		
DB RIPPER PT-115A 7" PT-115B 8" 	<ul style="list-style-type: none"> <li>• Vertical bolt on knife point.</li> <li>• Minimal soil throw.</li> <li>• Made from spring steel.</li> <li>• Available in 7" or 8" depths.</li> <li>• 13mm wide tungsten.</li> <li>• Optional nut welded on back of point for liquid transfer</li> </ul> <b>UPGRADES</b> <ul style="list-style-type: none"> <li>• Nut welded to rear of point - \$1.50. Add N to part number.</li> </ul>	\$56.20 \$59.80

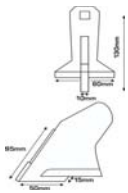
PRICES EXCLUDE GST

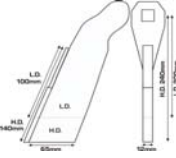
# SINGLE BOLT SEEDERS

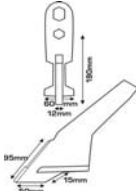
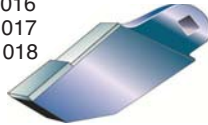
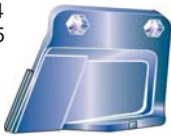

KNIFE POINTS			
PART NO	DIMENSIONS	FEATURES	PRICE
<b>MAXI KNIFE</b> PT-1002 		<p>Made from NiHard with a rating of 600 brinell for ultra long life. Tungsten tipped for ultimate blade protection. Hex bolt slot allows for one bolt to be fastened easily and efficiently with only one spanner required. This point has a tapered blade for longer life and elimination of wear at rear of blade before tungsten has reached full usage. Use one 2 1/4 x 7/16 B/N.</p>	\$42.30
<b>1 BOLT RIPPER</b> PT-1007 		<p>Made from NiHard with a rating of 600 brinell for ultra long life. Thicker and wider tungsten for increased blade protection and longevity. Hex bolt slot allows for one bolt to be fastened easily and efficiently with only one spanner required. This point has a tapered blade for longer life and elimination of wear at rear of blade before tungsten has reached full usage. Use one 2 1/4 x 7/16 B/N.</p>	\$44.80
<b>MAXI SEEDER</b> PT-1001 		<p>The Maxi Seeder is widely regarded as the most economical and consistent Inverted T point to suit cultivators or combines on the market. Hex bolt slot allows for one bolt to be fastened easily and efficiently with only one spanner required. Use one 2 1/4 x 7/16 B/N.</p>	\$50.90
<b>MAXIPLUS</b> PT-1004 		<p>Stronger neck for increased strength and ability to withstand shock loads on heavy duty cultivators. Thicker tungsten on underside of wing for increased wing protection and longevity. Use one 2 1/4 x 7/16 B/N.</p>	\$57.00
<b>SCARI RIPPER</b> PT-1009 		<p>Designed to suit Scarifier tyne profile. Made from NiHard with a rating of 600 brinell for ultra long life. Hex bolt slot allows for one bolt to be fastened easily and efficiently with only one spanner required. This point has a tapered blade for longer life and elimination of wear at rear of blade before tungsten has reached full usage. Use one 2 1/2 x 1/2 B/N.</p>	\$54.80
<b>FLEXIPLUS</b> PT-105A 7/16" PT-105B 1/2" 		<p>Inverted T design for minimum till practices and increased soil throw. Thicker tungsten on the underside of wing keeps wings intact for entire lifespan of the point. Around 50% longer life due to stronger neck, thicker tungsten, deeper banding and tougher wings.</p>	\$65.10 \$65.10
<b>BT POINT</b> A PT-1016 B PT-1017 C PT-1018 		<p>To suit Bourgault Titan series, available in 3 sizes. Two tungsten tiles with the thickest tile at the tip for wear resistance and longevity. Hardfacing welds on side to protect and strengthen blade as standard. A = Original; B = 1/2" Longer; C = 1" Longer</p>	\$68.50 \$68.50 \$68.50
<b>PASTURE POINT</b> A PT-1014 B PT-1015 		<p>Made from cast steel which offers consistent strength and long wear life. Two tungsten tiles keep the leading edge protected. Inverted T design. Tungsten tile on underside of wing for extended wing life.</p>	\$49.20

PRICES EXCLUDE GST

# SEEDING POINTS

ORDER NO	DESCRIPTION	TUNGSTEN WIDTH	TUNGSTEN LENGTH	BOLT SIZE	SUIT
<b>AGMASTER</b>					
PT1120 	NT11 12mm Knife Point	12MM	109MM	N/A	350LBS BREAKOUT
PT1160 	NT11 16mm Knife Point	16MM	124MM	N/A	HIGHER BREAKOUT TYPES
PT1190 	NT11 16mm Liquid Knife Point	16MM	124MM	N/A	HIGHER BREAKOUT TYPES
TSP	"T" Pin 10mm Diameter with Split Pin (4 x 25)				



ORDER NO	DESCRIPTION	TUNGSTEN WIDTH	TUNGSTEN LENGTH	BOLT SIZE	SUIT
<b>AGPOINT</b>					
32HDP-1AT	Heavy Duty Bolt on Knife Points	16MM	140MM	7/16	Bolt on Fit IHC V/ Shank, Leon, Flexi-coil, Gason, Hesston, Morris, Bourgault, Eze-On, Horwood Bagshaw ScariBar
32HDP-1TG 	Heavy Duty Bolt on Knife Points	16MM	105MM	7/16	
32HDP-2AT	Heavy Duty Bolt on Knife Points	16MM	140MM	1/2	
32HDP-2TG	Heavy Duty Bolt on Knife Blade	16MM	105MM	1/2	
M8THDP4-AT	Knock on Knife point 47 degrees AG Tuff	18MM	140MM	NA	Slim Wedge Fits North American Cultivators Flexicoil, IHC-Vibrashank, Bourgault, Horwood Bagshaw Scaribar, Gason 6100, Morris
M8THDP4-TG 	Knock on Knife point 47 degrees AG Tuff /Tile	18MM	70MM	NA	
M8THDP6-AT	Knock on Knife point 47 degrees AG Tuff	18MM	165MM	NA	
M8THDP6-TG	Knock on Knife point 47 degrees AG Tuff /Tile	18MM	105MM	NA	

PRICES EXCLUDE GST

# SEEDING POINTS

ORDER NO	DESCRIPTION	TUNGSTEN WIDTH	TUNGSTEN LENGTH	BOLT SIZE	SUIT
<b>AGPOINT</b>					
M8THDPS4-AT	Knock on Knife point 70 degrees	18MM	140MM	NA	Slim Wedge Fits North American Cultivators Flexicoil, IHC-Vibrashank, Bourgault, Horwood Bagshaw Scaribar, Gason 6100, Morris
M8THDPS4-TG	Knock on Knife point 70 degrees	18MM	70MM	NA	
M8TWS4-AT	Winged Knife Blade AG Tuff	18MM	140MM	NA	Slim Wedge Fits North American Cultivators Flexicoil, IHC-Vibrashank, Bourgault, Horwood Bagshaw Scaribar, Gason 6100, Morris
M8TWS4-TG	Winged Knife Blade Tungsten Tile	18MM	70MM	NA	
M8TWS6-AT	Winged Knife Blade AG Tuff	18MM	165MM	NA	
M8TWS6-TG	Winged Knife Blade Tungsten Tile	18MM	105MM	NA	



## 16mm KNIFE POINTS

ORDER NO	DESCRIPTION	PRICE
<b>AGPOINT</b>		
ASM001	KNIFE POINT 16MM STANDARD, TUNGSTEN 30mm x 16mm x 8mm	\$55.00
ASM002	KNIFE POINT 16MM SUPER, TUNGSTEN 40mm x 17mm x 8mm	\$71.25
ASM010	2 BOLT HOLE ADAPTOR	\$6.50
ASM011	ROLL PIN / SPLIT PIN	\$2.50

PRICES EXCLUDE GST

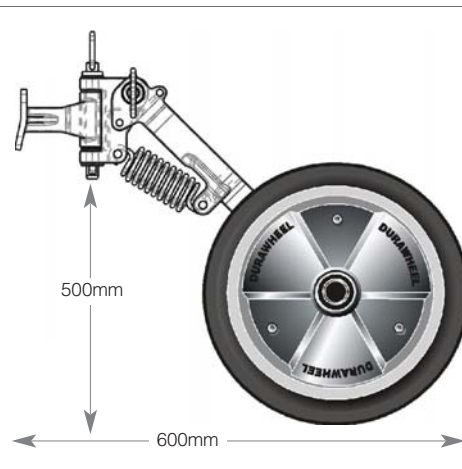
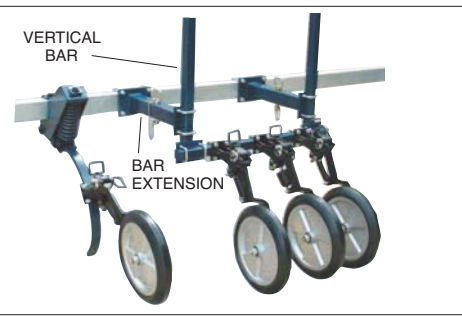

# SINGLE SYSTEM PRESS WHEEL

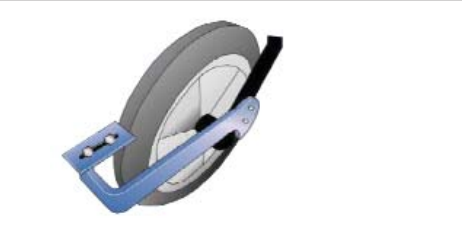
SS-1200		<p>Single Press Wheel Unit (includes Dura Wheel). Can be mounted directly behind tyne or at rear of seeder. All parts made from heavy duty cast steel for an incredibly strong frame and long service life. Simple robust design enables farmers to quickly change parts by simply releasing a lynch pin. Pressure adjustable.</p>	\$310.00
SP-1100		SINGLE SYSTEM INCLUDES WHEEL	
SS-0109		<p>Mounting arms are available from Maxipoint and come standard with adjustable height and quick change systems. (Shown in picture left).</p>	\$75.00
SS0110		BAR EXTENSION	\$140.00
SS-1216		<p><b>PRESS WHEEL SCRAPER</b> For use in very heavy soil conditions. Easy to fit and adjust, with tungsten tipped mud scraper. Includes brackets and fasteners.</p>	\$45.00



## PRESS WHEEL PARTS

SS-0610	SPRING	\$33.00
FA-0851	BEARING	\$8.45
SP-0601	SEAL	\$4.10
SP-0101	TYRE V	\$61.00
SP-0104	TYRE SQUARE	\$61.00

## PRESS WHEEL TOOL KIT

TO-1122	TOOL KIT FOR PRESS WHEELS	\$279
---------	---------------------------	-------

PRICES EXCLUDE GST

# PRESSWHEELS

ORDER NO	DESCRIPTION	TYRE SIZE
<b>K-HART PRESS WHEELS</b>		
PS50	PRESSWHEEL SINGLE AXLE	
PWA50	PRESSWHEEL TANDEM WALKING AXLE	
PD50	PRESSWHEEL FIXED DOUBLE	

<b>K-HART PRESS WHEEL SPARES</b>		
PWO313VT	TYRE ONLY	3 X 13 INCH V STYLE
PWO414VT	TYRE ONLY	4 X 14 INCH V STYLE
PWO313FT	TYRE ONLY	3 X 13 INCH FLAT STYLE
PWO416FT	TYRE ONLY	4 X 16 INCH FLAT STYLE
PWO316VT	TYRE ONLY	4 X 16 INCH V STYLE
PWO316FT	TYRE ONLY	4 X 16 INCH FLAT STYLE
PTA490	TRAILING ARM	NA

## K-HART PRESSWHEELS



PWA50

PD50

### Features:

- Precise row and seed packing, increases moisture retention.
- Swivel brackets, no dragging on turns.
- High grade rubber semi or pneumatic tyres.

Attach press wheels to most seeders telescope in and out, adjust up and down.



PTA490

PS50

ORDER NO	DESCRIPTION	SUITS
<b>FORWARD FARMING PRESSWHEEL</b>		
FF40054	PRESSWHEEL COMPLETE	FORWARD FARMING ASSY
FF40055	RUBBER TYRE ONLY	N/A
FF40057	ALUMINIUM RIM ONLY	N/A

### ARP PRESSWHEEL

FF40055	RUBBER TYRE ONLY	N/A
---------	------------------	-----

### SINGLE PRESS WHEEL UNIT

SS-0109	VERTICAL BAR
SS-0110	BAR EXTENSION
SS-1200	SINGLE SYSTEM INCLUDES WHEEL
SP-1100	WHEEL ONLY

### TRIPLE SYSTEM

TS-1300	3-WHEEL
TS-1500	5-WHEEL
TS-1101	PRESS WHEEL MOUNTING FRAMEWORK



SP



PP



FF40054

PRICES EXCLUDE GST

# TRIPLE / 5 GANG SYSTEM

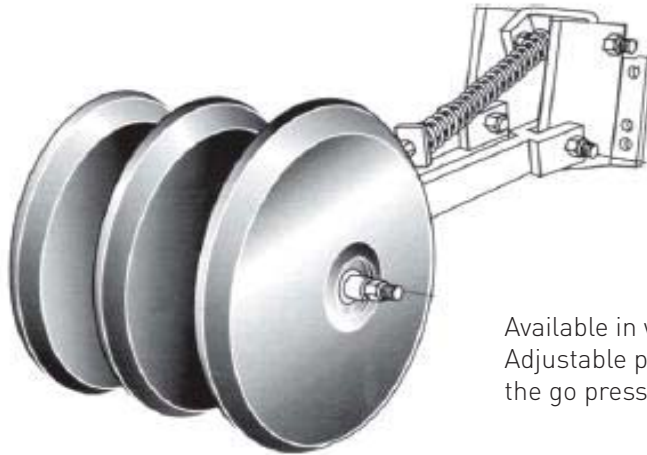

Available in widths from 175mm to 330mm. Adjustable pressure system allows for on the go pressure adjustments.

PART NO	DESCRIPTION	MACHINE FIT	WORKING PRESSURE	WHEEL SPACINGS	STUMP JUMP
TS-1300	PRESS WHEEL ASSEMBLY - 3 WHEELS	100 x 100 or 75 x 75 SHS	ADJUSTABLE	OPTIONAL 7, 8, 9, 10, 11, 12, 13 INCH SPACINGS	250MM
TS-1500	PRESS WHEEL ASSEMBLY - 5 WHEELS	100 x 100 or 75 x 75 SHS	ADJUSTABLE	OPTIONAL 7, 8, 9, 10, 11, 12, 13 INCH SPACINGS	250MM



The system can be supplied in gangs of 3 or 5 semi pneumatic wheels. The spring activated pressure system is constructed from 12mm steel. 6, 7, 8, 9, 10, 11, 12 inch spacings are available on order.

TS-1300	3 WHEEL	\$825.00
TS-1500	5 WHEEL	\$1240.00

### TRIPLE SYSTEM PARTS

TS-0301	T PIECE	\$58.00
TS-0302	SPRING	\$95.85
TS-0305	SLEEVE	\$25.10
TS-0350	AXLE	\$65.50
TS-0304	SADDLE	\$34.00



TS-1101  
\$135.00

### PRESS WHEEL MOUNTING FRAMEWORK

Heavy Duty Swivel Extension bolts to rear of Triple System, allowing wheels to track more accurately through the turns. Reduces drag, saves fuel.

### V PROFILE

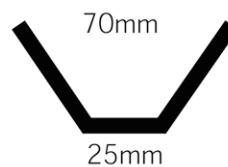

### SQUARE

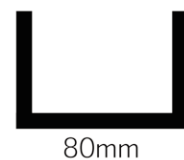

\*Specify tyre profile on press wheel order

PRICES EXCLUDE GST

# COULTERS

ORDER NO	DESCRIPTION	MAX PRESSURE RATING	AVAILABLE DISC SIZES	PRICE
<p><b>MAXIPOINT</b> CS-1300</p> 	<p><b>MAXIPOINT TWIN DISC COULTER SYSTEM</b></p> <ul style="list-style-type: none"> <li>• Heavy duty hubs.</li> <li>• Depth and pressure can be adjusted quickly and easily.</li> <li>• Available in 9, 10, 11 and 12 inch spacing. Other spacings are available on request.</li> <li>• 150° swivel for trouble-free cornering.</li> <li>• Greaseable pivot points.</li> <li>• Available with Flat or Rippled disc.</li> </ul>	3 SPRING OPTIONS	18 INCH	\$865
 				
<p><b>K-HART / YETTER COULTERS</b> CKH1650</p> 	<p>K-HART COULTER 2 1/4 DIA SHANK FOR STRENGTH AND FAST VERTICLE ADJUSTMENT SEALED TAPERED ROLLER BEARINGS</p>	1300 LBS		
<p>CY2995CL</p> 	<p>YETTER GENERATION 3 COULTER IMPROVES RESIDUE FLOW</p>	1300 LBS	17, 18, 20 INCH	

PRICES EXCLUDE GST



# COULTERS

ORDER NO	DESCRIPTION	MAX PRESSURE RATING	AVAILABLE DISC SIZES
<b>K-HART YETTER COULTERS</b>			
CY2995CR 	YETTER GENERATION 3 COULTER IMPROVES RESIDUE FLOW	1300 LBS	
CY2930 	YETTER ECONOMY VERSION CUTS MELON VINES, WIRE WEED AND STRAW	1300 LBS	17, 18, 20 INCH
ORDER NO	DESCRIPTION		
<b>DOUBLE DISC OPENERS</b>			
OKH3612LBA	K-HART LOW PROFILE DOUBLE DISC OPENER LEFT HAND BRACED ARM, SUITS MOST COMBINES		
OKH3612LQA	K-HART LOW PROFILE DOUBLE DISC OPENER LEFT HAND QUICK ADJUST, SUITS MOST COMBINES		
OKH3612RBA	K-HART LOW PROFILE DOUBLE DISC OPENER RIGHT HAND BRACED ARM, SUITS MOST COMBINES		
OKH3612RQA	K-HART LOW PROFILE DOUBLE DISC OPENER RIGHT HAND QUICK ADJUST, SUITS MOST COMBINES		
OKH4612LQA	K-HART PARALLELOGRAM DOUBLE DISC OPENER LEFT HAND WITH QUICK ADJUST PRESS WHEEL, OFFERS MINIMAL SOIL AND RESIDUE DISTURBANCE ACCURATE SEED PLACEMENT		
OKH4612RQA	K-HART PARALLELOGRAM DOUBLE DISC OPENER RIGHT HAND WITH QUICK ADJUST PRESS WHEEL, OFFERS MINIMAL SOIL AND RESIDUE DISTURBANCE ACCURATE SEED PLACEMENT		

COULTERS ARE IDEAL FOR IMPROVING TRASH FLOW ON SEEDING EQUIPMENT

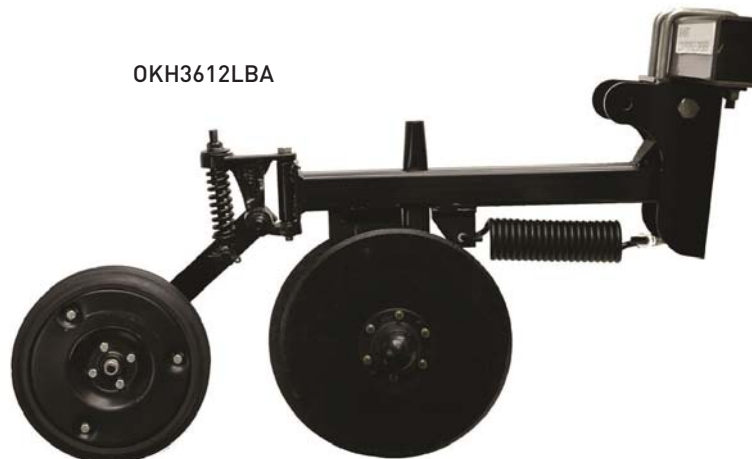

PRICES EXCLUDE GST

T: (08) 9362 6811

28

F: (08) 9361 3263

# SEED BRAKES

## NEW TO MAXIPOINT - AIRGUARD™ SEEDING PRECISION

Get better germination and crop consistency with AIRGUARD™ Seed Brakes by significantly improving seed and fertiliser placement.

Air speed is adjustable - controlled by a series of exhaust port washers - which balances air flow across the entire air seeder. Product is delivered to the furrow in a controlled manner, reducing airflow by 50%. **Easy to install with any type of air drill.**

### Improves yield

Optimises seed and fertiliser placement

### Reduces seed waste

Controlled airflow eliminates seed bounce and seed soil mixing.

### Minimises seed damage

The seed brake uses a spiral system to slow seed flow; there are no baffles for the seeds to hit against.

### Withstands abrasive products

Optional stainless steel body allows for placement of abrasive products like fertiliser potash and sulphur.

### Saves money

AIRGUARD™ Seed Brakes allow the reduction of seed rates due to more accurate seed placement.



PART NO	DESCRIPTION	PRICE
BS-7330	SEED BRAKE - 32MM	\$37.80
BS-7340	SED BRAKE 38MM	\$43.20
BS-7350	FULL EXHAUST SEED BRAKE - 32MM SS	\$35.10
BS-7360	SEED BRAKE - 38MM SS	\$106.00
BS-7400	WIND METER	\$45.20
BS-7336	EXHAUST PORT KIT	\$13.50
BS-7344	ADAPTER KIT FOR 7340 / 7360 - 38 - 32MM	\$9.70



BS-7330



BS-7350



BS-7360  
BS-7344 Adapters

PRICES EXCLUDE GST

# AIRSEEDER HEADS / RISER (RAYCOL)

ORDER NO	DESCRIPTION	INLET ID (MM)	NUMBER OF OUTLETS	OUTLET DIAMETER (MM)
<b>STAINLESS SECONDARY HEADS</b>				
SSC45532	C Type Head	45	5	32
SSC45632	C Type Head	45	6	32
SSC631025	C Type Head	63	10	25
SSC631032	C Type Head	63	10	32
SSC63632	C Type Head	63	6	32
SSC63725	C Type Head	63	7	25
SSC63732	C Type Head	63	7	32
SSC63925	C Type Head	63	9	25
SSC63932	C Type Head	63	9	32
SSD631025	D Type Head	63	10	25
SSD631125	D Type Head	63	11	25
SSD63832	D Type Head	63	8	32
SSE63632	E Type Head	63	6	32
SSE63732	E Type Head	63	7	32
SSE63832	E Type Head	63	8	32

MOST COMMONLY USED AIRSEEDER SECONDARY HEADS.  
OTHER COMBINATIONS ARE AVAILABLE ON REQUEST

ORDER NO	TYPE	DESCRIPTION
<b>SECONDARY RISERS</b>		
R176	R1	76mm R1 Riser Assembly
R163	R1	63mm R1 Riser Assembly
R150	R1	50mm R1 Riser Assembly
R145	R1	45mm R1 Riser Assembly
R276	R2	76mm R2 Riser Tube NO Bracket
R263	R2	63mm R2 Riser Tube NO Bracket
R250	R2	50mm R2 Riser Tube NO Bracket
R245	R2	45mm R2 Riser Tube NO Bracket
R376	R3	76mm R3 Adjustable Riser Assembly
R363	R3	63mm R3 Adjustable Riser Assembly
R350	R3	50mm R3 Adjustable Riser Assembly
R345	R3	45mm R3 Adjustable Riser Assembly



C

SSC63832



D

SSD631325



E

SSE631325

ORDER NO	A SIZE MM	B SIZE MM	C SIZE MM	D SIZE INCHES
<b>UBOLTS</b>				
UB42-07571	140MM	53MM	19MM	3.5
UB42-07730	155MM	33MM	16MM	4
UB42-315033	150MM	45MM	19MM	4
UB42-315034	150MM	45MM	19MM	6
UB42-07328	195MM	50MM	20MM	6
UB42-315031	230MM	50MM	19MM	7
UB42-315032	232MM	51MM	22MM	7
UB42-07547	267MM	64MM	19MM	8



R163



R263

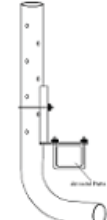

R363

ORDER NO	DESCRIPTION	ORDER NO	DESCRIPTION
<b>HIGH TENSILE CUP HEAD BOLTS</b>			
B4070	10mm X 40mm (3/8" X 1 1/2")	B2559	7/16" x 2" UNC
B4071	10mm x 45mm (3/8" x 1 3/4")	B2641	1/2" x 1 1/2" UNC
B4074	10mm x 50mm (3/8" x 2")	B2642	1/2" x 1 3/4" UNC
B4073	10mm x 65mm (3/8" x 2 1/2")	B2643	1/2" x 2" UNC
B2557	7/16" x 1 1/2" UNC	B2644	1/2" x 2 1/2" UNC
B2558	7/16" x 1 3/4" UNC		



PRICES EXCLUDE GST

# TYRESHIELD

## Prevent flat tyres on AG equipment



TyreShield® is an innovative concentrated liquid compound easily installed through the tyre valve after the removal of the tyre valve stem. After installation, simply drive the vehicle a few kilometers allowing the tyre rotation to distribute the product evenly throughout the inside of the tyre. Now, all porosity, bead, and rim leaks are sealed for the full legal life of the tyre.

Once a tyre has been treated with TyreShield® the compound creates a thin liquid film on the inside of the treated tyre which provides a barrier that maintains tyre pressure and creates a complete air tight container within the tyre and tyre rim. Optimum tyre pressure is improved for the full legal life of the tyre, and results in better tyre performance, improved fuel use, and increased safety.

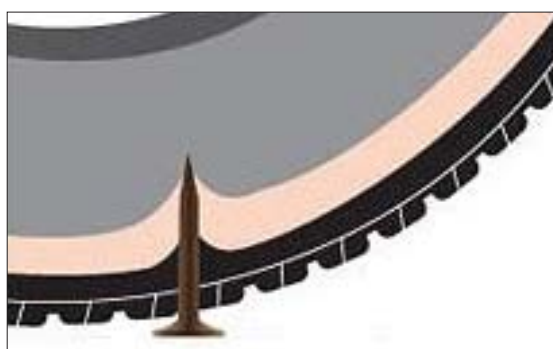

TyreShield® makes use of road & tyre friction to seal punctures while the vehicle is in motion. In the event of a puncture, the pressurized air inside the tyre trying to escape will immediately draw TyreShield® to the source of the leak and seal the hole created by the puncture, regardless if the puncturing object is removed or not. The seal is permanent, the tyre does not need to be removed and repaired, and eliminates the need for the driver to make immediate stops to check the tyre. Should a puncturing object be removed while the vehicle is stationary the tyre may loose pressure until the vehicle is in motion. For best results drive/ride the vehicle 2-5 km to ensure the leak is effectively sealed.

After installation, TyreShield® remains dormant inside the tyre until a puncture activates it.

ORDER NUMBER	DESCRIPTION	ORDER NUMBER	DESCRIPTION
<b>TYRE SHIELD</b>			
TSP2000	TYRE SHIELD 20 LITRE	TSP250	TYRE SHIELD 250ML
TSP1000	TYRE SHIELD 1 LITRE	TSP125	TYRE SHIELD 125ML
TSP500	TYRE SHIELD 500 ML		

### Recommended Minimum Tyre Doses

OFF ROAD TYRES WHICH WILL BE USED IN HIGH-RISK AREAS (3-4 PUNCTURES A DAY) CAN SAFELY INSTALL TWICE THE AMOUNT - DO NOT EXCEED ON HIGH SPEED ROAD VEHICLES

#### Typical Fill Amount (per tyre)

Bicycle 50ml road bike / 50 -75ml MTB

Motorcycle 75ml front / 125ml rear

All-Terrain Vehicle (ATV)/Large Golf Cart 150ml

Bob Cat Earth Mover 450 ml + depending on size

Scooter 50 - 75ml front / 75 - 100ml rear

Quad Bike/ Average Golf Cart 125ml

Average Truck Tyre 350 ml

#### Passenger Motor Vehicles

Tread Width Divide by 2 = Req ml

eg 225/40/18 = 225 divide by 2 = 112,5 ml per tyre

(You can round this amount down to the closest 25ml i.e 112,5 becomes 100ml)

PRICES EXCLUDE GST

**T: (08) 9362 6811**

**31**

**F: (08) 9361 3263**



# SUPA VEYAS

Wonderweld Pty Ltd is an Australian owned company located in Willowie, South Australia that manufactures the Supa-Veya Conveyor - an endless cleated belt conveyor for loading and unloading air seeder carts. The Supa-Veya Conveyor is gentle on products being conveyed and has a self-cleaning hopper to ensure less contamination.

Units range from 5.5m to 6.5m in length x 320mm wide belt x 50mm high cross cleats, but can be manufactured to your specifications.

Capacities in excess of 850kg at 45°.

Manufactured to suit a wide range of air carts including Horwood Bagshaw, Simplicity, Gason, Gyrat, Morris, Flexicoil, Ausplow and Symonds, with new makes and models being added to the list upon demand.

The Supa-Veya Conveyor whilst running smoothly is incredibly quiet to operate. The unit is also able to swing through the entire length of the bin without the hopper shifting on the ground due to the double acting armature system.

ORDER NO TOW BETWEEN	ORDER NO TOW BEHIND	ELEVATOR LENGTH	SUITS
<b>HORWOOD BAGSHAW</b>			
	SVHB4000BH	5.5 M	4000 LTR
SVHB6000BT	SVHB6000BH	6.0 M	6000 - 19,000 LTR
	SVHB21000BH	6.5 M	21,000 LTR
<b>SIMPLICITY</b>			
	SVSI6000BH	6.0 M	6000 - 9000 LTR
SVSI12000BT		6.0 M	12,000 LTR
SVSI17000BT	SVSI17000BH	6.0 M	17,000 LTR
<b>FLEXICOIL</b>			
	SVFC1720BH	6.0 M	1720 & 2320
<b>GASON</b>			
SVGS1850BT	SVGS1850BH	5.5 M	1850
SVGS1880BT	SVGS1880BH	6.0 M	1880
	SVGS2120BH	6.5 M	2120 & 2150
<b>GYRAL</b>			
	SVGY24BH	6.0 M	24 -21 STR
	SVGY30BH	6.0 M	30/40 -31 STR
SVGY30BT		6.0 M	30-38 STB
<b>AUSFLOW</b>			
	SVAP9000BH	6.0 M	9000 LTR
	SVAP10000BH	6.0 M	10,000 LTR
SVAP12000BT		6.0 M	12,000 LTR
<b>MORRIS</b>			
	SVMS7180BH	6.0 M	7180
	SVMS7240BH	6.0 M	7240
<b>OTHER</b>			
SVFE8BT		5.5 M	Forward 6 tonne & 680 Bins
SVSY8BT		5.5 M	Symonds 8000 LTR
SVSM8BT		6.0 M	8000 LTR

OTHER MODELS AVAILABLE UPON REQUEST  
\*\*\*\*PLEASE CALL FOR INFORMATION\*\*\*\*



PRICES EXCLUDE GST

T: (08) 9362 6811

32

F: (08) 9361 3263

# AIRSEEDER REPLACEMENT CONVEYOR BELTS

ORDER NO	APPLICATION	DESCRIPTION	QTY
<b>JOHN DEERE</b>			
CM16976	667	BLACK CONVEYOR BELT CENTRAL V GUIDE	1
CM19979	547, 647, 630	GREEN PVC CONVEYOR BELT	2
AA58782	350 & 430 BU Carts	CONVEYOR BELT HEAVY DUTY CLEATS	1

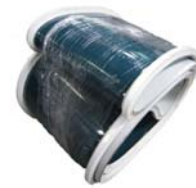

FE10376 -F10

## FORWARD ENGINEERS

CM16976	636, 660	BLACK CONVEYOR BELT WITH CENTRAL V GUIDE	1
CM19979	520, 620	GREEN PVC CONVEYOR BELT	2
FE10375-F10	640	GREEN PVC CONVEYOR BELT C/W GUIDE EITHER SIDE	1
FE10376-F10	6T, 680, 6120	GREEN PVC CONVEYOR BELT C/W GUIDE EITHER SIDE	1



CM16976

## SUPA VEYOR CONVEYORS

SVEY55	5.5 METRE CONVEYOR	GREEN PVC CONVEYOR BELT WITH HEAVY DUTY EXTENDED CLEATS	1
SVEY6	6.0 METRE CONVEYOR	GREEN PVC CONVEYOR BELT WITH HEAVY DUTY EXTENDED CLEATS	1
SVEY65	6.5 METRE CONVEYOR	GREEN PVC CONVEYOR BELT WITH HEAVY DUTY EXTENDED CLEATS	1



AA58782



# AIRSEEDER HEAVY DUTY FLEXIBLE COUPLING

## AIRSEEDER COUPLING

FFCOUP6	Poly Urethane Flexible 6" Coupling
FFCOUP8	Poly Urethane Flexible 8" Coupling



FFCOUP8

PRICES EXCLUDE GST

T: (08) 9362 6811

33

F: (08) 9361 3263

# AIRSEEDER HOSE

ORDER NO	DESCRIPTION	ID (MM)	OD (MM)
----------	-------------	---------	---------

## AIRSEEDER HOSE- PVC MID RANGE

AGPASC025	25mm Clear/Black Suction (20m Roll)	25	
AGPASC032	32mm Clear/Black Suction (20m Roll)	32	
AGPASC038	38mm Clear/Black Suction (20m Roll)	38	
AGPASC045	45mm Clear/Black Suction (20m Roll)	45	
AGPASC050	51mm Clear/Black Suction (20m Roll)	51	
AGPASC063	63mm Clear/Black Suction (20m Roll)	63	
AGPASC075	76mm Clear/Black Suction (20m Roll)	76	



## AIRSEEDER HOSE- PVC HEAVY DUTY

AGPASG025	25mm Grey PVC Suction (20m Roll)	25	
AGPASG032	32mm Grey PVC Suction (20m Roll)	32	
AGPASG038	38mm Grey PVC Suction (20m Roll)	38	
AGPASG050	51mm Grey PVC Suction (20m Roll)	51	
AGPASG063	63mm Grey PVC Suction (20m Roll)	63	
AGPASG075	76mm Grey PVC Suction (20m Roll)	76	



## AIRSEEDER HOSE- RUBBER

AGPASR032	32mm Rubber Suction (20m roll)	32	44
AGPASR038	38mm Rubber Suction (20m roll)	38	50
AGPASR044	44mm Rubber Suction (20m roll)	45	57
AGPASR050	50mm Rubber Suction (20m roll)	51	61
AGPASR063	63mm Rubber Suction (20m roll)	63	75
AGPASR076	75mm Rubber Suction (20m roll)	76	90
AGPASR100	100 (4") Rubber Suction	102	118
AGPASR125	125mm (5") Rubber Suction	127	145
AGPASR150	150mm (6") Rubber Suction	152	174
AGPASR200	200mm (9") Rubber Suction		



## AUGER / 5:1 BIN HOSE

D1RFH100	Flexible Ducting TPR 4"	100	107
D1RFH125	Flexible Ducting TPR 5"	127	134
D1RFH150	Flexible Ducting TPR 6"	150	157
D1RFH175	Flexible Ducting TPR 7"	180	188
D1RFH200	Flexible Ducting TPR 8"	200	208
D1RFH225	Flexible Ducting TPR 9"	225	233
D1RFH250	Flexible Ducting TPR 10"	250	259



## CLEAR TUBING

P/ASB023-030	Blue Flex Superior Airseeder Tube (30m Roll)	23	30
P/ASB024-030	Blue Flex Superior Airseeder Tube (30m Roll)	25	31.5
P/ASB025-030	Blue Flex Superior Airseeder Tube (30m Roll)	25	32
P/ASB032-030	Blue Flex Superior Airseeder Tube (30m Roll)	32	38



PRICES EXCLUDE GST

T: (08) 9362 6811

34

F: (08) 9361 3263

# SPARE PARTS

## BOURGAULT

ITEM CODE	DESCRIPTION	PRICE	ITEM CODE	DESCRIPTION	PRICE
AB-3001	Double Shoot. Includes holder, point and backshoot.	\$252.00	AB-1026	CK Point suits Bourgault Paralink.	\$79.00
AB-3002	Single Shoot. Includes holder, point and backshoot.	\$208.00			

## CASE CONCORD

ITEM CODE	DESCRIPTION	PRICE	ITEM CODE	DESCRIPTION	PRICE
AC4001	Boot assembly.	\$205.00	AC1260	Backshoot split.	\$79.00
AC1240	Backshoot fixed.	\$70.00	AC1280	Backshoot flexi.	\$83.00

## CHAMBERLAIN

ITEM CODE	DESCRIPTION	PRICE	ITEM CODE	DESCRIPTION	PRICE
PCHCAP4	Cap Plow 4	P.O.A.	PCHCNS	Arm nut 1" 12 TPI	P.O.A.
PCHCAP5	Cap Plow 5	P.O.A.	PCHP563	Pin	P.O.A.
PCHCAST5	Spindle Casting No 5/6	P.O.A.	PCHSP4B	Spindle plow 4 B/L	P.O.A.
PCH889	Nut disc	P.O.A.	PCHSPL	Spindle plow 5/6	P.O.A.
PCHASS5	Spindle casting ASS 5/6	P.O.A.	CHAM43949	Fertiliser Star clockwise Suit Mark 2 & 3	\$28.50
PCHB559	Bush	P.O.A.	CHAM43947	Fertiliser Star anti clockwise Suit Mark 2 & 3	\$28.50
PCHCAP6	Cap plow 6	P.O.A.	CHAM58566	Feed Gate. Suit Mark 2 & 3	\$8.35
PCHCN2	CH 5/6 C/nut 1 1/4	P.O.A.	AC6010	Disc Plain 5mm 33mm SQ	\$82.50

PRICES EXCLUDE GST

T: (08) 9362 6811

35

F: (08) 9361 3263



# SPARE PARTS

## CHAMBERLAIN

ITEM CODE	DESCRIPTION	PRICE	ITEM CODE	DESCRIPTION	PRICE
AC6015	Disc Plain 6mm 33mm SQ	\$93.95	AC6020	Disc Plain 5mm 33mm SQ	\$98.30



## EZEE-ON

ITEM CODE	DESCRIPTION	PRICE	ITEM CODE	DESCRIPTION	PRICE
AE1010	Disc 26 inch Plain. 8mm.	\$148.60	AE1011	Disc 26 inch Scallop. 8mm.	\$148.60



## FLEXICOIL

ITEM CODE	DESCRIPTION	PRICE	ITEM CODE	DESCRIPTION	PRICE
AF1001	Paired row. Point included.	\$295.00	PT-10SS	Stealth seeder.	\$55.80
AF1002	Side Banded. Point included.	\$265.00	PT-10SR	Stealth ripper.	\$45.70
AF1010	Electro Magnetic Clutch. Suits most models.	\$405.00			



## GRIZZLY

ITEM CODE	DESCRIPTION	PRICE	ITEM CODE	DESCRIPTION	PRICE
AG1010	Disc 28 inch scallop 8mm	\$165.10	AG1011	Disc 28 inch fluted 8mm	\$165.10



PRICES EXCLUDE GST

T: (08) 9362 6811

36

F: (08) 9361 3263

# SPARE PARTS

## FORWARD ENGINEERS

ITEM CODE	DESCRIPTION	PRICE	ITEM CODE	DESCRIPTION	PRICE
FE32501	Lift cylinder. Suits Forward Engineers FE 270. Supercedes CM17498	\$889.00	CM21134	Axle LH. Suits 636.	\$1,612.50
FE32502	Lift cylinder. Suits Forward Engineers FE 270. Supercedes CM16641	\$889.00	CM21135	Axle RH with pin. Suits 636.	\$1,612.50
FE32503	Hydraulic lift cylinder. Suits Forward Engineers 270, 853, 846. Supercedes CM17499	\$889.00	FE30076	Axle drive with pin. Suits 660.	\$1,512.00
FE32504	Hydraulic lift cylinder. Suits Forward Engineers 270, 853, 846. Supercedes CM17500	\$889.00	FE30012	Axle non drive. Suits 660.	\$1,512.00
CHAM73913	Engagement clutch. Suits Forward Engineers 846, 853, 620.	\$1,549.00	FE10188-F10	90mm axle. Suits 640, 680.	\$975.00
CM21562	Spring. Only suit CHAM73913.	\$238.00	FE10189-F10	100mm axle. Suits 640, 680.	\$975.00
CM20884	Engagement clutch. Suits Forward Engineers 636, 660.	\$985.00	FE10175-F10	Axle. Suits 6120.	\$2,575.00
CM21766	Spring. Only suit CM20884.	\$196.00	CM21955 FE33007	Tyne assembly. Suits 853, 846, 270.	\$685.00
CM16977	Solenoid suits 636, 620, 630, 660	\$332.50	CM21885	Shank only. Suits 853, 846, 270.	\$121.00
FE10486F20	Dog Clutch Sprocket. Suits Forward Engineers 640, 680, 6120 Rhino.	\$250.00	AN183318	Hub assembly. Suits 270.	\$375.00
FE10500F20	Dog Clutch Plain. Suits Forward Engineers 640, 680, 6120 Rhino.	\$150.00	CHAM64481	Hub. Cross Shaft Walkover Wheels. 4.6m thru 11.0m. Outrigger wheels 7.5 thru 16.5m. Suits 270.	\$496.00
FE31650	Dog Clutch Emu. Suits Emu 10000.	\$258.00	CHAM73962	Seed metering wheels. Suits 846, 853	\$9.25
FE31652	Dog Clutch Emu. Suits Emu 10000.	\$282.00	CHAM73963	Distributor gate. Suits 846, 853.	\$6.40
CHAM74759	Axle suit 5/8 pressed in studs. Suits 846, 853.	\$1,280.00	CHAM73964	Fertiliser wheels. Suits 846, 853.	\$11.40
CM21136	Axle tapped for 3/4 studs. Suits 846, 853.	\$1,187.00	CM19961	Support conveyor assembly stainless. Suits 520, 620, 630.	\$1,784.00

PRICES EXCLUDE GST























T: (08) 9362 6811

37

F: (08) 9361 3263

# SPARE PARTS

## JET STREAM 5:1

ITEM CODE	DESCRIPTION	PRICE	ITEM CODE	DESCRIPTION	PRICE
53291U	Casing Extended Front or Rear 	\$950.00	53284	Elevator Complete Std (Kit) no pulley. 49 Paddle.	\$1,365.00
53282U	Casing Standard Front or Rear 	\$950.00	53284A	Elevator Complete Std (Assembled) no pulley. 49 Paddle.	\$1,490.00
53292L	Chain 59 Paddle (Extended) 	\$275.00	19543	190mm Pulley to suit Side Elevator 	\$69.00
53292S	Chain 49 Paddle (Standard) 	\$275.00	24001/1	Sliding Tube 6" 	\$132.00
53260	Chain 15 Paddle Side Discharge 	\$115.00	24001/6	Square to Round 	\$75.00
53286	Shaft Top 292L 3/4" 	\$5.00	D1RFH150	Flexible Ducting 6" 1/2 metre 	\$38.00
53285	Shaft Bottom 356L 3/4" 	\$5.00	22120/061	Sprocket 1/2" x 15 Tooth 	\$40.00
10567	Bearing kit 3/4" (1 x EN204-12, 2 x 47MST, 2 x 8 x 20). 	\$27.50	22155/061	Sprocket 1/2" x 60 Tooth 	\$68.00
21070	Tension Spring 	\$24.50	22220/061	Sprocket 5/8" x 15 Tooth 	\$34.00
53287	Headslide Yoke 	\$45.00	22226/061	Sprocket 5/8" x 26 Tooth 	\$42.00
53287/2	Yoke Lever 	\$18.50	22349/041	Sprocket 5/8" x 30 Tooth 	\$68.00
01009N2	Eyebolt 	\$14.50	22521	Sprocket Top 10T Alternate 3/4" Bore 	\$65.00
53290	Elevator Complete Ext (Kit) no pulley. 59 Paddle.	\$1,365.00	22516	Sprocket Top 9T Alternate 3/4" Bore 	\$65.00
53290A	Elevator Complete Ext (Assembled) no pulley. 59 Paddle.	\$1,490.00	22510/061	Sprocket 7 Tooth Alternate 	\$92.00

PRICES EXCLUDE GST





T: (08) 9362 6811

38

F: (08) 9361 3263

# SPARE PARTS

## JET STREAM 5:1 CONTINUED

ITEM CODE	DESCRIPTION	PRICE	ITEM CODE	DESCRIPTION	PRICE
22515	Sprocket 9 Tooth Alternate Long Boss c/w Bush	\$170.65	22354F	Front Sprocket Dog Clutch	\$185.00
					
22353F	Front Dog Clutch	\$165.00	22354R	Rear Sprocket Dog Clutch	\$185.00
					
22353R	Rear Dog Clutch	\$165.00			
					

## JOHN DEERE / CONSERVA PAK

ITEM CODE	DESCRIPTION	PRICE	ITEM CODE	DESCRIPTION	PRICE
AJ1006	Conserva Point. Suits Conserva Pak.	\$65.70	CM21562	Spring only. Suit CHAM73913.	\$238.00
					
AJ1285	Seed Boot. Full tungsten tile protection.	\$60.00	CM20884	Engagement clutch. Suits John Deere 667.	\$985.00
					
AJ1286	Fertiliser Shoot.	\$42.00	CM21766	Spring only. Suit CM20884.	\$196.00
					
AJ1218	Presswheel Scraper.	\$15.00	CM16977	Solenoid suit 667, 647.	\$332.50
					
AJ1219	Bushings suit fertiliser shank.	\$9.50	CHAM74759	Axle suit 5/8 pressed in studs. Suits 746, 753.	\$1,280.00
					
FE32501	Lift cylinder. Suits John Deere 275 Supercedes CM17498	\$889.00	CM21136	Axle tapped for 3/4 studs. Suits 746, 753.	\$1,187.50
					
FE32502	Lift cylinder. Suits John Deere 275 Supercedes CM16641	\$889.00	CM21134	Axle LH. Suits 667.	\$1,612.50
					
FE32503	Hydraulic lift cylinder. Suits John Deere 275, 753, 746. Supercedes CM17499	\$889.00	CM21135	Axle RH with pin. Suits 667.	\$1,612.50
					
FE32504	Hydraulic lift cylinder. Suits John Deere 275, 753, 746. Supercedes CM17500	\$889.00	AJ1040	Solid flat tyre width 80mm OD 21 inches, suits 1820, 1830.	\$143.00
					
CHAM73913	Engagement clutch. Suits John Deere 746, 753.	\$1,549.00	AJ1041	Solid flat tyre width 100mm OD 21 inches, suits 1820, 1830.	\$143.00
					

PRICES EXCLUDE GST

T: (08) 9362 6811

39

F: (08) 9361 3263



# SPARE PARTS

## JOHN DEERE / CONSERVA PAK

ITEM CODE	DESCRIPTION	PRICE
AJ1050	15 inches aluminium rim/ tyre 80mm complete suits 1870	\$158.00
AJ1051	15 inches aluminium rim/ tyre 100mm complete suits 1870	\$168.00
CM21955 FE33007	Tyne assembly. Suits 753, 746, 275.	\$685.00
CM21885	Shank only. Suits 753, 746, 275.	\$121.00
AN183318	Suits 275.	\$375.00

ITEM CODE	DESCRIPTION	PRICE
CHAM64481	Hub. Cross Shaft Walkover Wheels. 4.6m thru 11.0m. Outrigger wheels 7.5 thru 16.5m. Suits 270.	\$496.00
CHAM73962	Seed metering wheels. Suits 746, 753.	\$9.25
CHAM73963	Distributor gate. Suits 746, 753.	\$6.40
CHAM73964	Fertiliser wheels. Suits 746, 753.	\$11.40
CM19961	Support conveyor assembly stainless. Suits 547, 647.	\$1,784.00

## MORRIS

ITEM CODE	DESCRIPTION	PRICE
AM2001	Paired Row or choice of Maxi Backshoots. Point included.	\$305.00
AM1030	CT Point suits Morris Contour 2.	\$45.00

ITEM CODE	DESCRIPTION	PRICE
AM1010	Electric Clutch 200lb (OEM Part No N33403) Suits 8000 Series.	\$545.00

## SIMPLICITY

ITEM CODE	DESCRIPTION	PRICE
AS1001	Electro Magnetic Clutch. Suits most models.	\$405.00
AS1005	Zero Max.	P.O.A.

ITEM CODE	DESCRIPTION	PRICE
AS1010	Gearbox 1:1 Ratio.	\$212.00
AS1015	Gearbox 3.3:1 Ratio.	\$267.00

PRICES EXCLUDE GST

T: (08) 9362 6811

40

F: (08) 9361 3263

# LIQUID EQUIPMENT

WETTERS	PRECISION WETTER	WetnGo	iWETTER
20 litre drum	PW20	WG20	IW20
110 litre drum	PW110	WG110	IW110
200 litre drum	PW200	WG200	IW200
1000 litre shuttle	PW1000	WG1000	IW1000



## PREMIUM SOIL CONDITIONING AGENT

**PRECISION WETTER IS AN AUSTRALIAN MADE AND UNIQUELY FORMULATED BLEND OF NEW GENERATION NON-IONIC, SURFACE-ACTIVE AGENTS DESIGNED TO ELIMINATE PROBLEMS CAUSED BY WATER REPELLANT SOILS.**

Precision Wetter is ideal for Non Wetting Soils

- Promotes deeper root growth
- Improves soil nutrient use
- Utilizes available moisture
- Economical and easy to use
- Eliminates 'Dry Patch'
- Reduces erosion
- Improves germination



Precision Wetter provides superior wetting to a variety of hydrophobic soil types including soils with low organic matter and it is balanced to provide the right amount of wetting span. Broadacre crops can benefit immensely by the application of a soil wetter into the soil close to the seed. This provides the environment for an even germination and sustained crop growth by ensuring that any soil moisture is readily available to the crop.

Precision Wetter provides superior wetting to a variety of hydrophobic soil types including soils with low organic matter and it is balanced to provide the right amount of wetting span. Broadacre crops can benefit immensely by the application of a soil wetter into the soil close to the seed. This provides the environment for an even germination and sustained crop growth by ensuring that any soil moisture is readily available to the crop.



SITUATION	APPLICATION RATE		COMMENTS
Broadacre Band Spray for Furrow Seeding	Press wheels at 25cm spacing	0.6 to 2L/ha	Maintain spray pressure at a rate high enough to produce a strong jet. Water rate: 50 to 100L/ha. Use higher rates for extremely high water repellent soils.
	Press wheels at 15cm spacing	1 to 4L/ha	
	Boom Spray	4 to 8L/ha	Ideally spray immediately before rain is due.
Seeding establishment	Band spray: 1 to 3L/ha Boom spray: 5 to 10L/ha		Water rate: 75 to 100L/ha
Landscaping with foliage	5 to 10L/ha		Preferable to water immediately after application to ensure soil contact.
Turf Management	Boom spray: 2.5 to 5L/ha		Water rate: 400 to 800L/ha Water every 15 to 30 days. Water well after application to ensure soil contact.

PRICES EXCLUDE GST

T: (08) 9362 6811

41

F: (08) 9361 3263

# A-i70



## A-i70 SINGLE LIQUID INJECTION

The A-i70 is our entry level single liquid auto-rate pump and control module. It is designed for single liquid application. The A-i70 integrates with Ag Leader®, Greenstar™, Topcon, Raven & Trimble, providing on-the-go rate control and full operational monitoring functionality. Spiker dosing system can be series coupled to this module with no requirement for extra hydraulic flow. Connected to a Stacker Distribution system, the A-i70 provides a complete liquid injection system, delivering the best precision, accuracy and flexibility with straight forward installation and operation.

New features include digital pump speed read out, external flush, source and function selection and purge to ground function.

FUNCTION	SINGLE LIQUID RATE CONTROL	
MAX OUTPUT	76 L/MIN	
DIMENSIONS	W X D X H 1000MM X 630MM X 521MM	
WEIGHT	153KG	
PUMP	HYDRAULICALLY DRIVEN BERTOLINI 76 L/MIN LQS ENHANCED PISTON DIAPHRAGM PUMP	
HYDRAULICS	30 L/MIN	
ELECTRICAL	12 VOLT 1.3 AMP	
FEATURES	<ul style="list-style-type: none"> <li>• STAINLESS STEEL CABINET</li> <li>• PRECISION VALVE SET INCORPORATING TEEJET BALL VALVES AND FLOW METRE</li> <li>• SUCTION FILTER</li> <li>• FERTILISER / CLEAN WATER SOURCE SELECTION</li> <li>• ALL TANK PLUMBING INCLUDING UMBILICAL LINE TO CONNECT TO STACKER DISTRIBUTION SYSTEM</li> <li>• FACTORY WET TESTED</li> <li>• DIGITAL PUMP SPEED READOUT</li> <li>• PRESSURE TRANSDUCER AND MODULE MOUNTED PRESSURE GAUGE</li> <li>• PURGE FUNCTION</li> </ul>	

# A-i120



FUNCTION	HIGH VOLUME SINGLE LIQUID RATE CONTROL	
MAX OUTPUT	126 L/MIN	
DIMENSIONS	W X D X H 900MM X 890MM X 760MM	
WEIGHT	102KG	
PUMP	HYDRAULICALLY DRIVEN BERTOLINI 126 L/MIN LQS ENHANCED PISTON DIAPHRAGM PUMP	
HYDRAULICS	30 L/MIN	
ELECTRICAL	12 VOLT 1.3 AMP	
FEATURES	<ul style="list-style-type: none"> <li>• STAINLESS STEEL CABINET</li> <li>• PRECISION VALVE SET INCORPORATING TEEJET BALL VALVES AND FLOW METRE</li> <li>• SUCTION FILTER</li> <li>• FERTILISER / CLEAN WATER SOURCE SELECTION</li> <li>• ALL TANK PLUMBING INCLUDING UMBILICAL LINE TO CONNECT TO STACKER DISTRIBUTION SYSTEM</li> <li>• FACTORY WET TESTED</li> <li>• DIGITAL PUMP SPEED READOUT</li> <li>• PRESSURE TRANSDUCER AND MODULE MOUNTED PRESSURE GAUGE</li> <li>• PURGE FUNCTION</li> </ul>	

PRICES EXCLUDE GST

# G22 MODULE ORDER CODE: LQS-G22



## G22 MODULE

The G22 is Liquid Systems state of the art dual liquid auto-rate system. The G22 gives the farmer the ability to apply two separate liquids with full independent rate control. Its higher capacity pumps provide the means to deliver higher application rates or provide additional tank agitation. The second pump can be switched off for single liquid application mode.

<b>FUNCTION</b>	HIGH VOLUME DUAL LIQUID RATE CONTROL (INDEPENDENT AUTO-RATE CONTROL OF TWO LIQUIDS)	
<b>MAX OUTPUT</b>	126 LPM	33 GPM (US) 27.7 GPM (IMPERIAL)
<b>DIMENSIONS</b>	W 1507MM X D 856MM X H 690MM	
<b>WEIGHT</b>	198KG (MODULE ONLY)	
<b>PUMP</b>	2X HYDRAULICALLY DRIVEN 126 LPM (33 US GPM) LQS ENHANCED PISTON DIAPHRAGM PUMPS	
<b>HYDRAULICS</b>	27.5 LPM	7.3 GPM (US) 6.0 GPM (IMPERIAL)
<b>ELECTRICAL</b>	12V 2.6A	
<b>FEATURES</b>	<ul style="list-style-type: none"> <li>• Factory wet tested</li> <li>• Digital pump speed readout</li> <li>• 2x Pressure transducers and module mounted pressure gauges</li> <li>• Purge function</li> <li>• Mapping based variable rate control when integrated with precision ag displays</li> <li>• All tank plumbing kits included (See Below)</li> </ul>	<ul style="list-style-type: none"> <li>• 2x Precision valve sets incorporating TeeJet ball valves and flow meters</li> <li>• Suction filters</li> <li>• Fertiliser/ clean water source selection</li> <li>• Can run in single liquid mode when required</li> <li>• Option: 180 Pump Upgrade to 170 LPM (45 GPM)</li> <li>• Umbilical line to connect to Stacker Distribution System included</li> </ul>

# SPIKER MODULE ORDER CODE: LQS-SPK



<b>FUNCTION</b>	LOW VOLUME SINGLE LIQUID DOSING. INJECT AT LOW RATES INTO OUTPUT LINE OF AI70, AI120 OR G22. IDEAL FOR MICRONUTRIENTS, FUNGICIDES, INOCULANTS, SOIL WETTERS ETC.	
<b>MAX OUTPUT</b>	24 LPM	6.3 GPM (US) 5.3 GPM (IMPERIAL)
<b>DIMENSIONS</b>	W 575MM X D 620MM X H 580MM	
<b>WEIGHT</b>	50KG (MODULE ONLY)	
<b>PUMP</b>	HYDRAULICALLY DRIVEN 24 LPM (6.3 US GPM) LQS ENHANCED PISTON DIAPHRAGM PUMP	
<b>HYDRAULICS</b>	21 LPM	5.5 GPM (US) 4.6 GPM (IMPERIAL)
<b>ELECTRICAL</b>	12V 1.3A	

PRICES EXCLUDE GST

**T: (08) 9362 6811**

**43**

**F: (08) 9361 3263**

# AIRTOOL MANIFOLD CONFIGURATIONS

## STANDARD

Our standard manifold configurations provide even distribution of liquid across tillage bars with up to 100 rows. Configurations are available with from one to six manifold assemblies, in single or dual liquid configurations. Each manifold is capable of delivering liquid to up to 20 rows. To avoid damage to delivery tubing, at least one manifold per folding section is required. i.e. a double fold tillage bar requires 5 manifolds.

### SINGLE

ORDER CODE	CONFIGURATION DESCRIPTION
LQS-ASST1	M1 Single Stacker (max. 20 outlets)
LQS-ASST2	M2 Single Stacker (max. 40 outlets)
LQS-ASST3	M3 Single Stacker (max. 60 outlets)
LQS-ASST4	M4 Single Stacker (max. 80 outlets)
LQS-ASST5	M5 Single Stacker (max. 100 outlets)
LQS-ASST6	M6 Single Stacker (max. 120 outlets)

Example. M3 Single Stacker



### DUAL

ORDER CODE	CONFIGURATION DESCRIPTION
LQS-ASSD1	M1 Dual Stacker (max. 40 outlets)
LQS-ASSD2	M2 Dual Stacker (max. 80 outlets)
LQS-ASSD3	M3 Dual Stacker (max. 120 outlets)
LQS-ASSD4	M4 Dual Stacker (max. 160 outlets)
LQS-ASSD5	M5 Dual Stacker (max. 200 outlets)
LQS-ASSD6	M6 Dual Stacker (max. 240 outlets)

Example. M3 Dual Stacker



PRICES EXCLUDE GST

T: (08) 9362 6811

44

F: (08) 9361 3263



# AIRTOOL MANIFOLD CONFIGURATIONS

## SECTION CONTROL

Section Control manifold configurations include a Section Control module. This module incorporates 3-way electric ball valves in a constant flow configuration for instantaneous shut-off with seamless rate control. The modules come with a stainless steel mounting bracket, pressure gauge and line filter.

### SINGLE

ORDER CODE	CONFIGURATION DESCRIPTION
LQS-ACST2	M2 Section Control Single Stacker (max. 40 outlets)
LQS-ACST3	M3 Section Control Single Stacker (max. 60 outlets)
LQS-ACST4	M4 Section Control Single Stacker (max. 80 outlets)
LQS-ACST5	M5 Section Control Single Stacker (max. 100 outlets)
LQS-ACST6	M6 Section Control Single Stacker (max. 120 outlets)
LQS-ACST8	M8 Section Control Single Stacker (max. 160 outlets)
LQS-ACST9	M9 Section Control Single Stacker (max. 180 outlets)

Example. M3 Section Control Single Stacker



### DUAL

ORDER CODE	CONFIGURATION DESCRIPTION
LQS-ACSD2	M2 Section Control Dual Stacker (max. 40 outlets per channel)
LQS-ACSD3	M3 Section Control Dual Stacker (max. 60 outlets per channel)
LQS-ACSD4	M4 Section Control Dual Stacker (max. 80 outlets per channel)
LQS-ACSD5	M5 Section Control Dual Stacker (max. 100 outlets per channel)
LQS-ACSD6	M6 Section Control Dual Stacker (max. 120 outlets per channel)
LQS-ACSD8	M8 Section Control Dual Stacker (max. 160 outlets per channel)
LQS-ACSD9	M9 Section Control Dual Stacker (max. 180 outlets per channel)



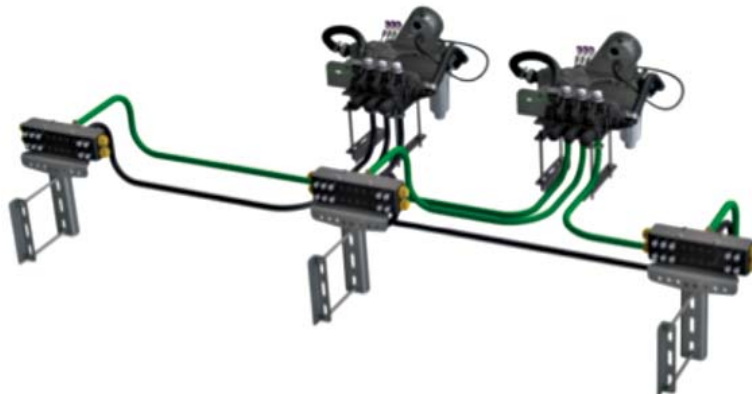



Example. M3 Section Control Dual Stacker



PRICES EXCLUDE GST

# AIRTOOL MANIFOLD CONFIGURATIONS







Liquid Systems has a range of terminal configurations for liquid distribution setups on air seeder tillage bars. With Air Tool Terminal Configurations, the line from each manifold outlet can be split into two separate delivery lines. All terminal configurations include in-line check valves for quick shut-off and start-up. All connections are push-fit for simple assembly and maintenance.

<p>Example: Standard Terminals connected to Stacker Manifold.</p>	<p><b>LOW RATE 4MM (A)</b> Order Code: LQS-ATL4</p>	<p><b>STANDARD</b> Order Code: LQS-ATST</p>
	 <ul style="list-style-type: none"> <li>• 8mm tees to split flow from manifold</li> <li>• 8mm delivery line</li> <li>• inline check valve</li> <li>• line meters included (choose 3 sizes)</li> <li>• 8-4mm Stem Reducer</li> <li>• V3 rubber union</li> <li>• 4mm OD x 1.8mm ID terminal tube</li> </ul> <p>Fits to 6.35mm (1/4") OD x 4.53mm ID stainless steel delivery tube (not included)</p> <p>Suitable for rates up to 100L/Ha, 10 US Gal/ Acre on 9-12" Spacing</p>	 <ul style="list-style-type: none"> <li>• 8mm tees to split flow from manifold</li> <li>• 8mm delivery line</li> <li>• inline check valve</li> <li>• line meters included (choose 3 sizes)</li> <li>• V4 rubber union</li> <li>• 5mm OD x 2.5mm ID terminal tube</li> </ul> <p>Fits to 9.53mm (3/8") OD x 6.27mm ID stainless steel delivery tube (not included)</p> <p>Good stream control across a wide range of application rates. For openers spaced 9"-15"</p>
<p><b>HIGH RATE</b> Order Code: LQS-ATHR</p>	<p><b>LOW VOLUME FIBP</b> Order Code: LQS-ATFB</p>	<p><b>DBS LOW VOLUME FIBP</b> Order Code: LQS-AT3F</p>
 <ul style="list-style-type: none"> <li>• 8mm tees to split flow from manifold</li> <li>• 8mm delivery line</li> <li>• inline check valve</li> <li>• line meters included (choose 3 sizes)</li> <li>• 8mm OD terminal tube</li> </ul> <p>Fits to 6.35mm (1/4") OD x 4.53mm ID stainless steel delivery tube (not included)</p> <p>Suitable for high rate applications or points with 1/4" liquid delivery tubes</p>	 <ul style="list-style-type: none"> <li>• 8mm tees to split flow from manifold</li> <li>• 8mm delivery line</li> <li>• inline check valve</li> <li>• 8-5mm stem reducer</li> <li>• V4 rubber union</li> <li>• 5mm OD x 1.2mm ID yellow terminal tube</li> </ul> <p>Fits to 9.53mm (3/8") OD x 6.27mm ID stainless steel delivery tube (not included)</p> <p>Permits large bore/ ultra-low application. Ability to apply difficult materials. No Line meter is used with this option as back pressure is created via line friction - the longer the line the higher the back pressure</p>	 <ul style="list-style-type: none"> <li>• 8mm tees to split flow from manifold</li> <li>• 8mm delivery line</li> <li>• inline check valve</li> <li>• 8-4mm stem reducer</li> <li>• 4mm OD x 1.8mm ID purple terminal tube (30mm length)</li> <li>• 4-3mm stem reducer</li> <li>• 12 x 3 Cable Gland</li> <li>• 1/4" V3 rubber union</li> <li>• 3mm OD x 1.2mm ID orange terminal tube</li> </ul> <p>Fits inside 6.35mm (1/4") OD DBS Stainless drop tube</p> <p>Permits large bore/ ultra-low application. Ability to apply difficult materials. No Line meter is used with this option as back pressure is created via line friction - the longer the line the higher the back pressure</p>









PRICES EXCLUDE GST

# LIQUID SYSTEMS SPARES



## 1 1/2" SUCTION FILTER ASSEMBLIES - MODULES - 176, Ai70 & Spiker

ITEM CODE	DESCRIPTION	UNIT	PRICE
3142462	1 1/2" 32 mesh Suction Filter	EACH	\$135.00
			
314000.050	O'-Ring for 1 1/2" Suction Filter Bowl	EACH	\$10.20
			
G10061	1 1/2" - Hose Tail 90 Degree	EACH	\$6.45
			
G10061	O'-Ring for 1 1/2" Fly Nut	EACH	\$1.80
			
2002060	1 1/2" Fly Nut	EACH	\$4.45
			
3142002.030	Suction Filter Screen 1-1/2" 32 Mesh	EACH	\$45.80
			









## 2" SUCTION FILTER ASSEMBLIES - MODULES - 276, Ai120 & G22

3162472	SHORT 2" 32 mesh 316 Series Suction Filter	EACH	\$180.00
			
316000.050	O'-Ring for 2" Suction Filter Bowl	EACH	\$16.30
			
3162002.030	SHORT 2" 32 mesh Suction Filter Screen	EACH	\$60.00
			
3172472	2" 32 mesh 317 Series Suction Filter	EACH	\$197.10
			
3172002.030	2" 32 mesh Suction Filter Screen	EACH	\$71.70
			
116740	2" Hose Tail 90°	EACH	\$9.30
			
2002070	2" Fly Nut	EACH	\$6.00
			
G100071	O' Ring for 2" Fly Nut	EACH	\$1.70
			

## 1 1/4" SELECTOR VALVE ASSEMBLIES: SOURCE Selector Valve - MODULES 176, Ai70, 276 & Spiker FUNCTION Selector Valve - MODULES 176, Ai70, 276, Ai120, G22 & Spiker

ITEM CODE	DESCRIPTION	UNIT	PRICE
45531115	1 1/4" 3 Way Ball Valve (Continuous Flow)	EACH	\$102.60
			
454235H.020	1 1/4" 3 Way Ball Only (Continuous Flow)	EACH	\$36.40
			
4542235.070	Teflon Seal for 1 1/4" 3 way ball valve	EACH	\$17.15
			

## 2073 PUMP - MODULES 176, PR-1, Ai70 & 276

689021	Series Hydraulic Sandwich Control Block	EACH	\$775.10
			
B79428	Isolating switch for Series Hydraulic Sandwich	EACH	\$165.80
			
31.8896.97.3-SHORT	Shortened Spline Shaft Coupler 2073/2136 & Housing	KIT	\$422.10
			
MR50CD	50CC Hydraulic motor	EACH	\$776.30
			
689904-20	Flow Control 20 LPM	EACH	\$1,013.15
			
95.0040.36.2	HPS Diaphragms for 2073 Pumps	EACH	\$67.10
			
63.9872.97.3	Valve Kit for 2073 Pumps 6 x 28.9809.97.3 (SS Valves) 6 x 80.3320.60.2 (Orings 5 x 40) 4 x 80.3219.80.2 (Orings 3,0 x 39)	KIT	\$583.60
			
80.2143.10.2	Viton Oil Seal (Dia. 35mm x 52mm x 7mm)	EACH	\$50.00
			
2073 EH Pump	Enhanced Bertolini 2073 Pump	EACH	\$1,605.30
			

PRICES EXCLUDE GST









T: (08) 9362 6811

47

F: (08) 9361 3263

# LIQUID SYSTEMS SPARES







## 2136 PUMP for MODULES - Ai120 & G22

ITEM CODE	DESCRIPTION	UNIT	PRICE
MR50CD	50CC Hydraulic motor	EACH	\$776.30
			
689904-20	Flow Control 20 LPM	EACH	\$1,013.15
			
703028	PWB2V Air Pressure Tank 2L 1" BSP	EACH	\$112.50
			
62.0040.36.2	HPS Diaphragm for 2136 Pumps	EACH	\$87.90
			
62.0040.00.2	Desmopan Diaphragm for 2136 Pumps	EACH	\$58.10
			
62.9805.97.3	Valve Kit for 2136 Pumps 6 x 28.9809.97.3 (SS Valves), 6 x 80.3314.00.2 (Orings 4,5 x 40)	KIT	\$578.70
			
80.2143.10.2	Viton Oil Seal (Dia. 35mm x 52mm x 7mm)	EACH	\$50.00
			
2136 EH Pump	Enhanced Bertolini 2136 Pump	EACH	\$2,369.50
			



## 2180 PUMP

689021 Block	Series Hydraulic Sandwich Control	EACH	\$775.00
			
B79428	Isolating switch for Series Hydraulic Sandwich	EACH	\$165.80
			
31.8895.97.3 shortened	Hydraulic Coupler (Bell Housing) to suit 2180 with shortened spline	KIT	\$573.50
			
MR50CD	50CC Hydraulic motor	EACH	\$776.30
			
689904-20	Flow Control 20 LPM	EACH	\$1,013.15
			
62.0040.36.2	HPS Diaphragm for 2180 Pumps (4 x Diaphragms required for 2180 pump)	EACH	\$87.90
			

## 2180 PUMP continued

ITEM CODE	DESCRIPTION	UNIT	PRICE
62.0040.00.2	Desmopan Diaphragm for 2180 Pumps	EACH	\$58.10
			
28.9884.97.3	Valve Kit for 2180 Pump. 8 x 28.9809.97.3 (SS Valves) 8 x 80.3314.00.2 (Orings 4,5 x 40) 4 x 80.3209.40.2 (Orings 2,62 x 44,12)	KIT	\$779.90
			
28.9809.97.3	SS Valve for Bertolini Pumps	EACH	\$137.90
			
80.3314.00.2	O-ring for Bertolini Pump Valves	EACH	\$6.90
			
80.2143.10.2	Viton Oil Seal (Dia. 35mm x 52mm x 7mm)	EACH	\$50.00
			
2180 EH Pump	Enhanced Bertolini 2180 Pump	EACH	\$3,953.70
			

## PRESSURE RELIEF VALVE - All Modules Except Spiker

MPRV100-100	100 PSI Pressure Relief Valve	EACH	\$153.30
			
FC100	1" Flange Clamp	EACH	\$18.85
			
M100G	1"EPDM Gasket ('O' ring)	EACH	\$4.00
			

## TANK AGITATION

5022043	Small Tank Agitator with 3mm Nozzle	EACH	\$30.50
			
5022045	Small Tank Agitator with 5mm Nozzle	EACH	\$30.50
			
502163	Large Tank Agitator with 3mm Nozzle	EACH	\$86.10
			
502165	Large Tank Agitator with 5mm Nozzle	EACH	\$86.10
			

PRICES EXCLUDE GST







T: (08) 9362 6811

48



F: (08) 9361 3263

# LIQUID SYSTEMS SPARES

## RATE CONTROL MODULE VALVE SETS

ITEM CODE	DESCRIPTION	UNIT	PRICE
57-10100	TeeJet 801 Flowmeter	EACH	\$847.40
			
16-00024	Sensor Insert, 801 Flowmeter	EACH	\$299.00
461BEC-2F-C shut Off	460 Manifold Shut Off Valve	EACH	\$681.10
			
LS-2 way DT	Deustch DT 2 wire connector for regulating valve	EACH	\$5.80
			
LS-Metri-Pack	3 wire Metri-Pack connector for shutoff valve or section valve	EACH	\$11.30
			
56610-18-460BR	Liquid Systems Custom TeeJet 460 Regulating Valve	EACH	\$780.00
			
LL03087	0-10 bar Pressure Transducer with lead & connector	EACH	\$329.15
			
TL2	Pressure Transducer with lead & connector	EACH	\$692.60
			

## SECTION CONTROL

431EC-3-D	TeeJet 430 3 way manifold section valve	EACH	\$496.85
			
58480EC-05	0.5m 3 wire mini-din cable for section valve	EACH	\$27.80
			
LS-Metri-Pack	3 wire Metri-Pack connector for shutoff valve or section valve	EACH	\$11.60
			









## MODULE PRESSURE GAUGE KITS

LL03003	Module Dual Scale 10 Bar Back Mount Pressure Gauge Assembly [Kit includes fixings]	KIT	\$531.60
			



## MODULE PRESSURE GAUGE KITS continued

ITEM CODE	DESCRIPTION	UNIT	PRICE
505.888.345804	PR-1 Gauge 0/10 Dual Scale 1/2" NPT Direct Bottom mount	EACH	\$371.60
			

## SPIKER

8630001	Spiker Shut-off Valve	EACH	\$507.30
			
4621AA00000	Orion Flowmeter 0.5-10 LPM	EACH	\$2,453.40
			
8630026S	Spiker Regulating Valve	EACH	\$592.20
			
465521	Pressure Relief Valve	EACH	\$268.70
			
505.7731079.10	Spiker Pressure Gauge Sggle Scale 0/1600KPA BottMount	EACH	\$254.70
			
MM32C	31.8cc Hydraulic Motor inc mounting flange	EACH	\$592.10
			
94.9871.97.3	2025 Diaphragm Kit for 2025 Pumps 2 x 94.0040.31.2 (Buna Diaphragms), 1 x 94.0041.31.2 (Damper Daiphram) 4 x O rings	EACH	\$84.60
			
94.9888.97.3	Valve Kit for 2025 Pumps 4 x 94.9828.97.3 [SS Valve Assy] 4 x 82.4154.50.20 [Gasket]	KIT	\$96.40
			
VENT 20	Venturi 20MM Injector	EACH	\$338.60
			
94.8609.97	Bertolini 2025 Poly PM- VF 2020 outlet	EACH	\$1,135.40
			

## STACKER DISTRIBUTION SYSTEMS

PPM0208W	Equal Tee 8mm Minimum Order 10	EACH	\$6.00
			
PPM0408W	Equal joiner 8mm Minimum Order 10	EACH	\$3.90
			

PRICES EXCLUDE GST

T: (08) 9362 6811

49

F: (08) 9361 3263



# LIQUID SYSTEMS SPARES

## STACKER DISTRIBUTION SYSTEMS continued

ITEM CODE	DESCRIPTION	UNIT	PRICE
PPM0808W	Plug 8mm Minimum Order 10	EACH	\$1.80
PM060804E	Stem Reducer OD 8mm-OD 4.0mm Minimum Order 10	EACH	\$3.60
PM060805E	Stem Reducer OD 8mm-OD 5.0mm Minimum Order 10	EACH	\$3.80
PM060806E	Stem Reducer OD 8mm-OD 6.0mm Minimum Order 10	EACH	\$3.80
PM061008E	Stem Reducer OD 10mm-OD 8.0mm Minimum Order 10	EACH	\$4.20
5-16SCV	5/16" Single Check Valve Min. Order 10	EACH	\$31.50
KQ2H23-04A	Push in Reducer 4mm-3.2mm Minimum Order 10	EACH	\$8.40
TRFMG12	M12mm x 3mm Nylon Cable Gland Minimum Order 10	EACH	\$2.00
PM2308E	8mm Two Way Divider Minimum Order 10	EACH	\$7.50
PM2310E	10mm Two Way Divider Minimum Order 10	EACH	\$7.70
M100075BRB	1" Flange x 3/4" Hose Barb	EACH	\$3.50
PM1210E	10mm Bulkhead Connector	EACH	\$10.50
M100075FPT	1" Flange x 3/4" Female Thread	EACH	\$4.00
MCV100	1" Flanged Check Valve	EACH	\$30.50
PPMSV 040808W	8mm Shut-off Valve	EACH	\$13.40

## STACKER DISTRIBUTION SYSTEMS continued

ITEM CODE	DESCRIPTION	UNIT	PRICE
UV075FP	3/4" Single Union Ball Valve	EACH	\$37.80
LL08001	In Line Check Valve	EACH	\$24.20
21950-2-NYB	TeeJet 2 PSI end cap	EACH	\$6.50
CP21953-VI	Diaph. Viton 21950 Minimum Order 5	EACH	\$2.60
L08050	Check Valve Elastomer Boot	EACH	\$4.60
CP-C08M	8mm Collet - replacement for manifolds, check valves and 8mm push-in fittings Minimum Order 10	EACH	\$2.20
CA-R08M-S	O-ring for check manifolds, check valves and 8mm push-in fittings. Min. Order 20	EACH	\$0.53
LM055RED	0.55mm Red Line Meter. Min. Order 10	EACH	\$4.30
LM070GRN	0.70mm Green Line Meter. Min. Order 10	EACH	\$4.30
LM085BLU	0.85mm Blue Line Meter. Min. Order 10	EACH	\$4.30
L08015	1/4" V3 Rubber Union to suit 6.35mm SS Tube. Min. Order 5	EACH	\$6.30
<i>Pre 2012 STACKER Terminal Assembly or LQS-ATL4 &amp; LQS-ATL4X Air Seeder Terminal Low Rate Configurations</i>			
L08016	5mm V4 Rubber Union to suit 9.53mm SS Tube. Min. Order 5	EACH	\$6.30
<i>LQS-ATST Air Seeder Terminal Standard Rate Configuration</i>			
L08017	6mm V4 Rubber Union to suit 9.53mm SS Tube. Min. Order 5	EACH	\$6.30
TSNIP	Tube Cutting Tool	EACH	\$12.50

PRICES EXCLUDE GST



T: (08) 9362 6811

50













F: (08) 9361 3263

# LIQUID SYSTEMS SPARES

## STACKER DISTRIBUTION SYSTEMS continued

ITEM CODE	DESCRIPTION	UNIT	PRICE
70843	Line Meter Pliers	EACH	\$61.90
			
COM-0013-SM	Line Meter Separator (Compression) Tool	EACH	\$6.95
			
<i>(Use the Compression Tool to depress the Locking Collets on the STACKER Manifold quick release insert cartridges when inserting or extracting the 8.0mm PE tubing.)</i>			
FC100	1" Flange Clamp	EACH	\$18.80
			
M100G	1" EPDM Gasket (O'ring)	EACH	\$4.00
			
HB075-90	0° Elbow 3/4" Male Thread x 3/4" Hose Barb	EACH	\$3.15
			
HBT075	3/4" Hose Barb Tee	EACH	\$4.40
			
LL08057	Single Manifold Assembly Includes Lid, 'O' rings & Cartridges, Bolts & Plugs	EACH	\$144.20
			
LL08003	Manifold	EACH	\$100.00
			
L08005	Stainless S Manifold Lid	EACH	\$12.70
			
L08066	Manifold Spacer Plate - 12mm	EACH	\$14.00
			
L08071	Manifold Fitting Gasket Seal	EACH	\$10.60
			
LL08201	3/4" Barb Fitting	EACH	\$10.40
			
LL08202	3/4" Plug Fitting	EACH	\$10.10
			
LL08203	3/4" Nipple Fitting	EACH	\$10.10
			

## STACKER DISTRIBUTION SYSTEMS continued

ITEM CODE	DESCRIPTION	UNIT	PRICE
LIQ21	3/4" BSP Plug	EACH	\$8.30
			
AAB126ML-F75-80	F75-80 Flange Strainer BSPT #80 Mesh Filter Screen	EACH	\$121.00
			
CP15941-3-SSPP	50 Mesh Filter Screen for AA126 Line Strainer	EACH	\$33.60
			
CP15941-4-SSPP	80 Mesh Filter Screen for AA126 Line Strainer	EACH	\$33.60
			
CP15941-5-SSPP	100 Mesh Filter Screen for AA126 Line Strainer	EACH	\$33.60
			
M12X250 304 SS AT	M12X250 304 SS All Thread Stud	EACH	\$11.00
			
L08029	Adaptor Angle Bracket	EACH	\$56.70
			
L08023	Universal Manifold Bracket	EACH	\$84.80
			
L08025	Universal Manifold Landing Plate	EACH	\$75.30
			
2003 3/4	S/S BSP Swing Check Valve	EACH	\$48.30
			
505.888.116962	STACKER Dual Scale 10 Bar Back Mount Liquid Systems 3 hole Flange Pressure Gauge	EACH	\$449.50
			
LL08080	STACKER Dual Scale 10 Bar Pressure Gauge Kit Includes bracket and fixings	KIT	\$537.90
			
PM010812E	1/4" BSP 8mm straight adaptor	EACH	\$3.80
			

PRICES EXCLUDE GST

T: (08) 9362 6811

51

F: (08) 9361 3263

# LIQUID SYSTEMS SPARES

## STACKER DISTRIBUTION SYSTEMS continued

ITEM CODE	DESCRIPTION	UNIT	PRICE
LL08099	Terminal Jet - Replacement Solution Consists of: 1 x JG-PM0408W (8mm straight joiner) 1 x JG-PM060804E (8mm-4mm stem reducer) 1m x BL-204352 (4mm OD x 1.8mm ID purple tube)	EACH	\$8.30
204385-03200S	3.0mm OD X 1.2mm ID Orange Terminal Tube. Min. Order 20m	200m roll	\$275.00 \$1.65/m
204352-200R	4.0mm OD X 1.8mm ID Purple Terminal Tube Minimum Order 20m	200m roll	\$253.00 \$1.50/m
204394-200R	5.0mm OD X 1.2mm ID Yellow Terminal Tube Minimum Order 20m	200m roll	\$380.00 \$2.25/m
204390-200R	5.0mm OD X 2.5mm ID Black / Yellow Terminal Tube Minimum Order 20m	200m roll	\$230.00 \$1.35/m
204396-200R	6.0mm OD X 4.2mm ID Yellow/ Black Terminal Tube Minimum Order 20m	200m roll	\$210.00 \$1.25/m
204402-08200	8mm OD x 5.2mm ID Black / Yellow Delivery Tube	200m roll	\$295.00 \$1.75/m
PE-1007-100m-E	10mm OD x 7 mm ID Black Terminal Tube	100m roll	\$230.00 \$1.35/m
T006.3CASA	6.3 OD x 1.2 WT 316 SS Seamless Tube	CUT TO SUIT	\$22.30/m \$5.00/cut
T009.5DASA	9.5 ODx 1.6W 316 SS Seamless Tube	CUT TO SUIT	\$27.90/m \$5.00/cut

## MONITORS, WIRING LOOMS & ELECTRONICS

LL03087	Wika Transducer Assembly AA-WIKA - Transducer Loom, WK-531.0.13066880 - A10 Pressure Transducer	KIT	\$329.15
LL03014	Pump RPM Monitoring Kit RPM monitor, AA-C2929 Monitor Loom & Pump RPM Sensor	KIT	\$565.15

## MONITORS, WIRING LOOMS & ELECTRONICS continued

ITEM CODE	DESCRIPTION	UNIT	PRICE
FMD300RPM + L03015	Pump RPM monitor with fascia plate	EACH	\$413.70
LL03017	Pump RPM Sensor fan sensor, fan magnet & fixings	KIT	\$180.90
C2929	Pump RPM Monitor Loom	EACH	\$90.50
L2RCKIT	L2 Rate Controller Kit	KIT	\$4,421.00
SP SEN Kit	Ground Speed Sensor Kit (L2 controller)	KIT	\$285.30
L2 Harness Assembly	L2 Loom Assembly includes 1 x AA-H1212; 1 x AA-H1213/20M & 1 x H1214	KIT	\$1,562.10
H1212	L2 Tractor Loom 10m	EACH	\$548.40
X20 Kit	Topcon X20 Loom Kit includes 1 x AA-C2457 & 1 x AA-H1214	KIT	\$740.00
C2457	Topcon X20 Cross-over Loom	EACH	\$221.00
H1213/10M	L2/X20 Extension Loom 10m	EACH	\$388.40
H1213/20M	L2/X20 Extension Loom 20m	EACH	\$494.70
H1213/2M	L2/X20 Extension Loom 2m	EACH	\$253.70
H1213/5M	L2/X20 Extension Loom 5m	EACH	\$310.50
H1214	L2/X20 Module Loom 10m	EACH	\$518.90

PRICES EXCLUDE GST

T: (08) 9362 6811

52

F: (08) 9361 3263

# LIQUID SYSTEMS SPARES

## MONITORS, WIRING LOOMS & ELECTRONICS continued

ITEM CODE	DESCRIPTION	UNIT	PRICE
1013026-01	Topcon Apollo CM40 Adaptor Loom	EACH	\$494.70
C2352	Greenstar Rate Controller Loom 10m	EACH	\$243.15
C2923	Greenstar Section Control Loom 10m	EACH	\$277.90
C2923-2M	Section Control Loom 2m	EACH	\$273.70
C2923-10M	Section Control Loom 10m	EACH	\$315.80
C2923-5M	Section Control Extension Loom 5m	EACH	\$149.50

## MONITORS, WIRING LOOMS & ELECTRONICS continued

ITEM CODE	DESCRIPTION	UNIT	PRICE
LL07001	Trimble Adaptor Loom	EACH	\$457.90
LL07002	Greenstar Section Control Adaptor Loom 7-10 sections	EACH	\$407.40
LL07003	Section Control Loom 7-10 Sections	EACH	\$703.15
LL07004	Ag Leader Adaptor Loom	EACH	\$436.80
LL07005	Section Loom Extension 5m (7-12 Sections)	EACH	\$305.30
LL07006	Greenstar Adaptor Loom 10m Extension	EACH	\$251.60

ORDER NO	DESCRIPTION	SUITS
<b>LIQUID SYSTEMS SPARE PARTS FOR MODULES</b>		
MR50CD	HYDRAULIC MOTOR	Ai-70, Ai-120, G22
689904-20	FLOW CONTROL 20LPM	Ai-70, Ai-120, G22
950040362	DIAPHRAGMS (3) 2073 PUMP	Ai-70
620040362	DIAPHRAGMS (3) 2136 PUMP	Ai-120, G22
639872973	VALVE KIT 2073 PUMP	Ai-70
629805973	VALVE KIT 2136 PUMP	Ai-120, G22
BESHAFT	SHAFT SEAL KIT VITON	Ai-70, Ai-120, G22
MPRV100	100 PSI PRESSURE RELIEF VALVE	Ai-70, Ai-120, G22
FC100	1" FLANGE CLAMP	Ai-70, Ai-120, G22
M100G	1" EPDM GASKET	Ai-70, Ai-120, G22



MR50CD



689904-20



639872973



BESHAFT



MPRV100



FC100



M100G

PRICES EXCLUDE GST

T: (08) 9362 6811

53

F: (08) 9361 3263



# HYPRO FLOW CONTROL

## MF-Valveset



Metered flow valve set.  
Suit Hydro centrifugal pump.

\$3,790.00 + GST



METERED FLOW VALVE SET  
(for centrifugal pumps)

## LIQUID SYSTEMS RATE TABLE

	WATER (SG 1.0) l/min											
	0.5 bar	1 bar	1.5 bar	2 bar	2.5 bar	3 bar	3.5 bar	4 bar	4.5 bar	5 bar	5.5 bar	6 bar
★ Red 0.55	0.125	0.160	0.190	0.225	0.255	0.285	0.302	0.315	0.335	0.355	0.360	0.375
★ Green 0.70	0.185	0.255	0.300	0.345	0.385	0.415	0.445	0.465	0.500	0.520	0.560	0.580
★ Blue 0.85	0.310	0.434	0.520	0.610	0.630	0.680	0.730	0.780	0.810	0.830	0.855	0.900
1.0	0.335	0.450	0.530	0.630	0.710	0.760	0.800	0.850	0.890	0.930	0.950	1.000
1.1	0.525	0.640	0.880	1.020	1.110	1.140	1.305	1.350	1.245	1.425	1.480	1.620
★ Yellow 1.2	0.650	0.890	1.050	1.170	1.240	1.280	1.380	1.480	1.500	1.600	1.660	1.740
1.3	1.040	1.480	1.800	2.020	2.160	2.370	2.490	2.650	2.790	2.820	2.970	3.050
1.5	1.200	1.550	1.900	2.100	2.225	2.410	2.525	2.675	2.800	2.850	3.000	3.100
★ Black 1.7	1.600	2.100	2.500	2.625	2.800	3.000	3.175	3.300	3.480	3.600	3.750	3.900
2.0	1.950	2.600	3.100	3.500	3.900	4.100	4.400	4.550	4.850	5.100	5.300	5.600
★ Grey 2.5	2.200	3.250	3.900	4.800	5.200	5.600	6.000	6.400	7.050	7.200	7.800	8.100
	UAN (SG 1.32); 42.5% N (W/V); 32.0% N (W/W) l/min											
	0.5 bar	1 bar	1.5 bar	2 bar	2.5 bar	3 bar	3.5 bar	4 bar	4.5 bar	5 bar	5.5 bar	6 bar
★ Red 0.55	0.115	0.150	0.185	0.210	0.225	0.260	0.270	0.282	0.295	0.305	0.320	0.332
★ Green 0.70	0.245	0.160	0.215	0.255	0.300	0.335	0.357	0.380	0.395	0.420	0.445	0.465
★ Blue 0.85	0.275	0.370	0.450	0.490	0.520	0.560	0.600	0.630	0.660	0.700	0.720	0.740
1.0	0.285	0.380	0.465	0.536	0.580	0.630	0.680	0.720	0.766	0.770	0.814	0.870
1.1	0.400	0.546	0.670	0.740	0.840	0.904	1.035	1.110	1.155	1.206	1.245	1.329
★ Yellow 1.2	0.500	0.670	0.800	0.910	1.000	1.065	1.155	1.215	1.260	1.305	1.335	1.395
1.3	0.950	1.300	1.600	1.800	1.925	2.050	2.175	2.285	2.390	2.500	2.570	2.665
1.5	1.000	1.370	1.650	1.850	2.000	2.100	2.200	2.380	2.500	2.600	2.700	2.765
★ Black 1.7	1.290	1.400	2.000	2.200	2.385	2.500	2.630	2.780	2.900	3.000	3.125	3.200
2.0	1.600	2.250	2.685	3.040	3.290	3.650	3.920	4.100	4.300	4.420	4.600	4.800
★ Grey 2.5	2.100	2.830	3.400	3.850	4.220	4.600	5.000	5.350	5.600	5.830	6.000	6.420

\* LINE METERS AVAILABLE EX STOCK - OTHER SIZES ON REQUEST

### LIQUID SYSTEM LINE METER SELECTION

W = Width of bar / air tool (metres)  
R = Rate (Litre per hectare)  
S = Speed (Kilometres per hour)  
N = Number of outlets

RATE  
(litres per minute per outlet)

$$\frac{W \times R \times S}{600 \times N}$$

RATE  
(litres per minute total)

$$\frac{W \times R \times S}{600}$$

PRICES EXCLUDE GST

T: (08) 9362 6811

54

F: (08) 9361 3263



# CHEMICAL TRANSFER SOLUTIONS

ITEM CODE	DESCRIPTION	UNIT	PRICE	ITEM CODE	DESCRIPTION	UNIT	PRICE
744-409	Micromatic FCC Coupler 3 Pin (Herbicide)	EACH	\$401.00	R1435M-825	Chemtraveller kit no flowmeter	EACH	\$2,665.30
744-408	Micromatic FCC Coupler 4 Pin (Insecticide)	EACH	\$418.90	R1435M	Chemtraveller kit with standard flowmeter and Micromatic fittings	EACH	\$3,192.60
744-085	4 Pin (Insecticide)	EACH	\$378.90	R1435-825	Chemtraveller kit with no flowmeter or Micromatic fittings	EACH	\$2,107.40
729-826	Micromatic Coupler Service Kit suits above FCC Couplers	EACH	\$69.50	R1435A	Chemtraveller kit with Air Sensing flowmeter but no Micromatic fittings	EACH	\$2,728.40
729-848	Suits pree-FCC, older Couplers	EACH	\$72.60	R1415-X670	Pump and 12 Volt Motor only c/w cable gland	EACH	\$2,011.60
799-010	Coupler Rebuild. 744-408 and 744-409 only	EACH	\$125.30	R1400KTF6863	Service kit to suit 400 Series Sotera Pumps	EACH	\$541.00
2DV3-001	Micromatic Rinser 3 Pin (Herbicide)	EACH	\$156.80	R1400KTH1457	Service kit to suit 400B Series Sotera Pumps	EACH	\$541.00
2DV4-001	Micromatic Rinser 4 Pin (Insecticide)	EACH	\$164.20	R1HPNSP	Piston type Hand Pump	EACH	\$287.40
R1825	Sotera electronic flow meter Series 825	EACH	\$528.40	R1HPNSPM	As above with Micromatic Coupler and Rinser	EACH	\$863.20
R1850	Sotera electronic flow meter Series 850 with Air Elimination	EACH	\$621.00	R1HPNH0	Hose kit (2m) to suit with Nozzle	EACH	\$67.40
R1825MKC	Sotera suction meter kit 825 flowmeter	EACH	\$1,226.30	R135LH	Volumetric hand pump one litre. Hose and non- drip nozzle kit	EACH	\$608.40
R1850MKC	Sotera suction meter kit 850 flowmeter	EACH	\$1,338.90	R135LH	Volumetric hand pump one litre. Micromatic Coupler and rinser	EACH	\$1,184.20
R1435MA	Chemtraveller kit	EACH	\$3,286.30				

PRICES EXCLUDE GST

T: (08) 9362 6811

55

F: (08) 9361 3263

# HYDRAULIC TRANSFER PUMPS

ORDER NO	DESCRIPTION	MAX CAP	MAX PRESS	PORTS IN	PORTS OUT
<b>SERIES 9000 HYPRO SELF PRIMING CAST IRON (C) &amp; STAINLESS STEEL (S)</b>					
9303C-HM2C SP	Hyd. Driven Pump (Oil Flow 15-22 LPM)	370 LPM	4.8 BAR	1 1/2"	1 1/4"
9303S-HM2C SP	Hyd. Driven Pump (Oil Flow 15-22 LPM)	370 LPM	4.8 BAR	1 1/2"	1 1/4"
9303C-HM4C SP	Hyd. Driven Pump (Oil Flow 19-26 LPM)	363 LPM	5.5 BAR	1 1/2"	1 1/4"
9303S-HM4C SP	Hyd. Driven Pump (Oil Flow 19-26 LPM)	363 LPM	5.5 BAR	1 1/2"	1 1/4"
9303C-HM1C SP	Hyd. Driven Pump (Oil Flow 14-49 LPM)	460 LPM	7.6 BAR	1 1/2"	1 1/4"
9303C-HM5C SP	Hyd. Driven Pump (Oil Flow 49-60 LPM)	460 LPM	7.6 BAR	1 1/2"	1 1/4"
9305C-HM3C SP	Hyd. Driven Pump (Oil Flow 57-76 LPM)	650 LPM	9.6 BAR	2"	2"
<b>SERIES 9000 HYPRO CAST IRON HYDRAULICALLY DRIVEN</b>					
9303C-HM2C	Hyd. Driven Pump (Oil Flow 15-22 LPM)	356 LPM	5.5 BAR	1 1/2"	1 1/4"
9303C-HM4C	Hyd. Driven Pump (Oil Flow 19-26 LPM)	416 LPM	6.2 BAR	1 1/2"	1 1/4"
9303C-HM1C	Hyd. Driven Pump (Oil Flow 41-49 LPM)	424 LPM	8.2 BAR	1 1/2"	1 1/4"
9303C-HM5C	Hyd. Driven Pump (Oil Flow 49-60 LPM)	549 LPM	9.6 BAR	1 1/2"	1 1/4"
9303C-HM3C	Hyd. Driven Pump (Oil Flow 57-76 LPM)	473 LPM	5.5 BAR	1 1/2"	1 1/4"
9304C-HM1C	Hyd. Driven Pump (Oil Flow 41-49 LPM)	740 LPM	7.6 BAR	2"	1 1/2"
9304C-HM5C	Hyd. Driven Pump (Oil Flow 49-60 LPM)	760 LPM	6.2 BAR	2"	1 1/2"
9305C-HM3C	Hyd. Driven Pump (Oil Flow 57-76 LPM)	685 LPM	12.4 BAR	2"	1 1/2"
9306C-HM1C	Hyd. Driven Pump (Oil Flow 41-49 LPM)	784 LPM	8.2 BAR	2"	1 1/2"
9306C-HM5C	Hyd. Driven Pump (Oil Flow 49-60 LPM)	803 LPM	9 BAR	2"	1 1/2"
9306C-HM3C	Hyd. Driven Pump (Oil Flow 57-76LPM)	810 LPM	9 BAR	2"	1 1/2"
9307C-GM10	Hyd. Driven Pump (Oil Flow 60-83 LPM)	1390 LPM	9 BAR	3"	2"
<b>SERIES 9000 HYPRO STAINLESS STEEL HYDRAULICALLY DRIVEN</b>					
9303S-HM2C	Hyd. Driven Pump (Oil Flow 15-22 LPM)	365 LPM	5.5 BAR	1 1/2"	1 1/4"
9303S-HM4C	Hyd. Driven Pump (Oil Flow 19-26 LPM)	416 LPM	6.2 BAR	1 1/2"	1 1/4"
9303S-HM1C	Hyd. Driven Pump (Oil Flow 41-49 LPM)	424 LPM	8.3 BAR	1 1/2"	1 1/4"
9303S-HM5C	Hyd. Driven Pump (Oil Flow 49-60 LPM)	549 LPM	9 BAR	1 1/2"	1 1/4"
9306S-HM1C	Hyd. Driven Pump (Oil Flow 41-49 LPM)	784 LPM	8.2 BAR	2"	1 1/2"
9306S-HM5C	Hyd. Driven Pump (Oil Flow 49-60 LPM)	803 LPM	9 BAR	2"	1 1/2"
9306S-HM3C	Hyd. Driven Pump (Oil Flow 57-76 LPM)	810 LPM	9 BAR	2"	1 1/2"



Series 9303S



Series 9305C



Series 9306C



Series 9307C



Series 9306S

PRICES EXCLUDE GST

T: (08) 9362 6811

56

F: (08) 9361 3263

## PUMPING EQUIPMENT

ENGINE	HP	SINGLE IMPELLER O/N	TWIN IMPELLER O/N	INLET BSP	OUTLET BSP
<b>DAVEY PUMP FIREFIGHTER</b>					
BARE SHAFT	N/A	5150P	5250P	1 1/2"	2 X 1 1/2", 2 X 1"
WET END REPLACEMENT SUIT ALL 51 & 52 CODED PUMPS	N/A	5158C	5258C	1 1/2"	2 X 1 1/2", 2 X 1"
HONDA GX160	5.5	5155H	5255H	1 1/2"	2 X 1 1/2", 2 X 1"
BRIGGS & STRATTON	6.0	5160B	5260B	1 1/2"	2 X 1 1/2", 2 X 1"
HONDA GX200	6.5	5165H	5260B	1 1/2"	2 X 1 1/2", 2 X 1"
HONDA GX200 ELECTRIC START	6.5	5165HE	5265HE	1 1/2"	2 X 1 1/2", 2 X 1"
YANMAR DIESEL C/W FRAME	7.0	5170Y	5270Y	1 1/2"	2 X 1 1/2", 2 X 1"
YANMAR DIESEL ELECTRIC START C/W FRAME	7.0	5170YE	5270YE	1 1/2"	2 X 1 1/2", 2 X 1"

<b>DAVEY PUMP FIREFIGHTER PRO</b>					
B & S VANGUARD ELECTRIC START	9.0	N/A	5290BE	2"	1 X 2", 2 X 1"
HONDA GX270 ELECTRIC START	9.0	5190HE	5290HE	2"	1 X 2", 2 X 1"
B&S VANGUARD ELECTRIC START	13.0	N/A	5213BE	2"	1 X 2", 2 X 1"
HONDA GX390 ELECTRIC START	13.0	5113HE	5213HE	2"	1 X 2", 2 X 1"
YANMAR DIESEL ELECTRIC START C/W FRAME	10.0	5110YE	5210YE	2"	1 X 2", 2 X 1"
YANMAR DIESEL ELECTRIC START C/W FRAME	10.0	N/A	5210YE/HP	2"	1 X 2", 2 X 1"



5150P



5155H



5265H



5290HE



5210YE

### FOAM-FAST

Simple to use foam dispersal systems for solid stick Class A foam. Ideal for home owners, farmers or personnel with limited training. Foam-fast is biodegradable, makes water 5 times wetter and can be stored for five years!

ORDER NO	DESCRIPTION	FLOW (LPM)	INLET
<b>FOAM-FAST</b>			
4010R-3LB	Foam-fast kit to suit Standard Garden Hose	12	3/4" BSP
4010R-30B	Foam-fast kit to suit 1" fire Hose	120	1" BSP
4012R-12T	Foam-fast 12" Replacement Cartridges	N/A	N/A



Foam-fast in Operation 1" nozzle

PRICES EXCLUDE GST

T: (08) 9362 6811

57

F: (08) 9361 3263

# PUMPING EQUIPMENT

ORDER NO	ENGINE	DESCRIPTION	SEALS	INLET BSP	OUTLET BSP
<b>FLEX-N POLY PACER PUMPS</b>					
AGP50H-PV	6.5HP HONDA	POLY PACER WITH 706 IMPELLER	VITON	2"	2"
AGP50H-PVF	6.5HP HONDA	POLY PACER WITH 706 IMPELLER C/W FRAME	VITON	2"	2"
AG50-PV	N/A	POLY PACER WITH 706 IMPELLER WET END SUIT MOTOR SHAFT 3/4"	VITON	2"	2"
AG50-PMV	N/A	POLY PACER WITH 706 IMPELLER BARE SHAFT 3/4"	VITON	2"	2"
AGP80H-PV	6.5HP HONDA	POLY PACER WITH 706 IMPELLER	VITON	3"	3"
AGP80H-PVF	6.5HP HONDA	POLY PACER WITH 706 IMPELLER C/W FRAME	VITON	3"	3"
AG80-PV	N/A	POLY PACER WITH 706 IMPELLER WET END SUIT MOTOR SHAFT 3/4"	VITON	3"	3"
AG80-PMV	N/A	POLY PACER WITH 706 IMPELLER BARE SHAFT 3/4"	VITON	3"	3"
AGKIT32	N/A	SEAL KIT TO SUIT 2 & 3" POLY PACER PUMPS	VITON	N/A	N/A
<b>FLEX-N POLY PACER HYDRAULIC DRIVEN PUMP</b>					
FWH50-PV		PACER HYD. DRIVEN PUMP 36 LITRES @ 1550 PSI	VITON	2"	2"
FWH80-PV		PACER HYD. DRIVEN PUMP 36 LITRES @ 1550 PSI	VITON	3"	3"
<b>DAVEY BOOMSPRAY PUMPS</b>					
5150PV3	N/A	DAVEY SINGLE IMPELLER BARE SHAFT	VITON	2"	1 X 2", 2 X 1"
5165HV3	6.5HP HONDA	DAVEY SINGLE IMPELLER PUMP	VITON	2"	1 X 2", 2 X 1"
5250PV3	N/A	DAVEY TWIN IMPELLER BARE SHAFT	VITON	2"	1 X 2", 2 X 1"
5265HV3	6.5HP HONDA	DAVEY TWIN IMPELLER PUMP	VITON	2"	1 X 2", 2 X 1"
<b>ALUMINIUM TRANSFER PUMPS</b>					
AGP50H	5.5HP HONDA	ALUMINIUM TRANSFER PUMP	EDPM	2"	2"
AGP50H-F	5.5HP HONDA	ALUMINIUM TRANSFER PUMP C/W FRAME	EDPM	2"	2"
AGP80H	5.5HP HONDA	ALUMINIUM TRANSFER PUMP	EDPM	3"	3"
AGP80H-F	5.5HP HONDA	ALUMINIUM TRANSFER PUMP C/W FRAME	EDPM	3"	3"



AGP80H-PV



5150PV3



5265HV3



AGP80H-F



POLY PACER 2 INCH PUMPS



5170Y MOUNTED ON ARMY DUCK

## DAVEY ISO SPEC PUMPS

USED IN A RANGE OF APPLICATIONS:

- RURAL IRRIGATION
- PRESSURE BOOSTING
- FIRE SERVICES
- COMMERCIAL POOLS



PRICES EXCLUDE GST

T: (08) 9362 6811

58

F: (08) 9361 3263



# COMPACT FIRE FIGHTING UNITS

Quality fire fighting units that are made in W.A., these heavy duty poly tanks have the highest UV resistance. Different designs to suit specific applications. Quality trouble free hose reel with 33m of fire hose and nozzle. All units fully tested and ready to go.

## Original Compact Units - AC

Designed to fit across a standard Ute tray, leaves over half the ute tray free to use. Keeps the load forward of the rear axle. Reel and motor on the drivers side for easy access. Galvanised SHS frame. Tank has full draining sump to suit chemical applications

- 500L - 1720mm W x 870mm L x 960mm H
- 800L - 1740mm W x 870mm L x 960mm H

3 Way suction includes 6m of suction line with strainer and camlock connection. Standard with Honda GX160 5.5hp coupled with Onga Pump.



CODE	DESCRIPTION	PRICE
AC500C	500LT COMPACT UNIT FULLY PLUMBED STANDARD	\$2,945
AC500C3W	500LT COMPACT UNIT FULLY PLUMBED 3WAY SUCTION	\$3,100
AC800C	800LT COMPACT UNIT FULLY PLUMBED STANDARD	\$3,030
AC800C3W	800LT COMPACT UNIT FULLY PLUMBED 3WAY SUCTION	\$3,190



PRICES EXCLUDE GST

T: (08) 9362 6811

59

F: (08) 9361 3263



# COMPACT FIRE FIGHTING UNITS

Quality fire fighting units that are made in W.A., these heavy duty poly tanks have the highest UV resistance. Different designs to suit specific applications. Quality trouble free hose reel with 33m of fire hose and nozzle. All units fully tested and ready to go.

## Diesel Powered Skid - AD

Electric start 5hp diesel powered engine, suitable for Mine site application. Fitted with a spill tray. Galvanised Angle steel frame. Tank has full draining sump to suit chemical applications.

- 500L - 1720mm W x 870mm L x 960mm H
- 800L - 1740mm W x 870mm L x 960mm H



CODE	DESCRIPTION	PRICE
AD1000	1000LT DIESEL SKID UNIT FULLY PLUMBED STANDARD	\$6,485.50
AD1200	1200LT DIESEL SKID UNIT FULLY PLUMBED STANDARD	\$7,450.00
AD1600	1600LT DIESEL SKID UNIT FULLY PLUMBED STANDARD	\$7,720.00

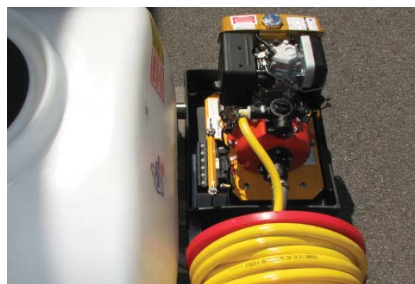

PRICES EXCLUDE GST

T: (08) 9362 6811

60

F: (08) 9361 3263

# COMPACT FIRE FIGHTING UNITS

Quality fire fighting units that are made in W.A., these heavy duty poly tanks have the highest UV resistance. Different designs to suit specific applications. Quality trouble free hose reel with 33m of fire hose and nozzle. All units fully tested and ready to go.

## Skid Units - AE

600L, 800L, 1000L, 1200L, 1600L, 2000L. Flooded suction to the pump. Zinc coated frame.

- 600L - 1800mm L x 1185mm W x 700mm H
- 800L - 1800mm L x 1185mm W x 825mm H
- 1000L - 1800mm L x 1185mm W x 1010mm H

3 Way suction includes 6m of suction line with strainer and camlock connection. Standard with Honda GX160 5.5hp coupled with Onga Pump.



CODE	DESCRIPTION	PRICE
AE600C	600LT ECO UNIT FULLY PLUMBED	\$2,475.00
AE600C3W	600LT ECO UNIT FULLY PLUMBED WITH 3 WAY SUCTION	\$2,870.00
AE800C	800LT ECO UNIT FULLY PLUMBED	\$2,575.00
AE800C3W	800LT ECO UNIT FULLY PLUMBED WITH 3 WAY SUCTION	\$2,980.00
AE1000C	1000LT ECO UNIT FULLY PLUMBED	\$2,680.00
AE1000C3W	1000LT ECO UNIT FULLY PLUMBED WITH 3 WAY SUCTION	\$3,070.00



PRICES EXCLUDE GST

T: (08) 9362 6811

61

F: (08) 9361 3263

# COMPACT FIRE FIGHTING UNITS

Quality fire fighting units that are made in W.A., these heavy duty poly tanks have the highest UV resistance. Different designs to suit specific applications. Quality trouble free hose reel with 33m of fire hose and nozzle. All units fully tested and ready to go.

## Square Fire Unit

Designed to fit all Dual Cab Well Body utes. Also suits other small space applications. 1120mm wide at the base, to fit most modern well bodies. Keeps the load forward of the rear axle. Zinc angle frame.

- 400L - 1200mm W x 1450mm L x 715mm H
- 600L - 1200mm W x 1450mm L x 900mm H
- 800L - 1200mm W x 1450mm L x 1000mm H

Standard with Honda GX160 5.5hp coupled with Onga Pump. Bolting to Plastic Pallet option.



CODE	DESCRIPTION	PRICE
AES400C	400LT SQUARE UNIT FULLY PLUMBED	\$2,385.00
AES400C3W	400LT SQUARE UNIT FULLY PLUMBED WITH 3 WAY SUCTION	\$2,780.00
AES600C	600LT SQUARE UNIT FULLY PLUMBED	\$2,475.00
AES600C3W	600LT SQUARE UNIT FULLY PLUMBED WITH 3 WAY SUCTION	\$2,870.00
AES800C	800LT SQUARE UNIT FULLY PLUMBED	\$2,570.00
AES800C3W	800LT SQUARE UNIT FULLY PLUMBED WITH 3 WAY SUCTION	\$2,970.00



PRICES EXCLUDE GST

T: (08) 9362 6811

62

F: (08) 9361 3263



# DAVEY REMOTE START FIREFIGHTER

## WHY CHOOSE THE DAVEY REMOTE START FIREFIGHTER?

For added security in a bushfire situation, or to eliminate travel time to a remotely located pump, the Davey Remote Start Firefighter provides a number of options for starting and stopping; manually, remotely via SMS or automatically.



Start options are:

- Electric (via key switch) or recoil starter
- SMS start (subject to subscription and reception)
  - Immediate, delayed start or timed run
- Heat sensors (Davey optional accessory P/N: 402939)
- Remote switch, e.g. float switch, panic button in house, etc.

The pump unit can only be stopped by the following methods:

- Key switch on engine turned to OFF position
- SMS stop signal or SMS timed run expired
- Engine stop due to no fuel remaining or oil alert system shut down.

Multiple users can be registered to operate and receive SMS feedback.

All registered users receive SMS feedback and warnings, such as:

- Pump Start and Pump Stop
- Battery Low
- General Status
- Engine Service and SIM Subscription reminders.

The SIM in the unit's control centre is factory fitted and ready to use utilising the Telstra 3G network across Australia. Ongoing use of the SMS function is subject to reception and subscription status.

## APPLICATIONS

- Firefighting
- External home fire protection sprinkler systems
- Tanker to tanker water transfer
- High head general water transfer
- Irrigation

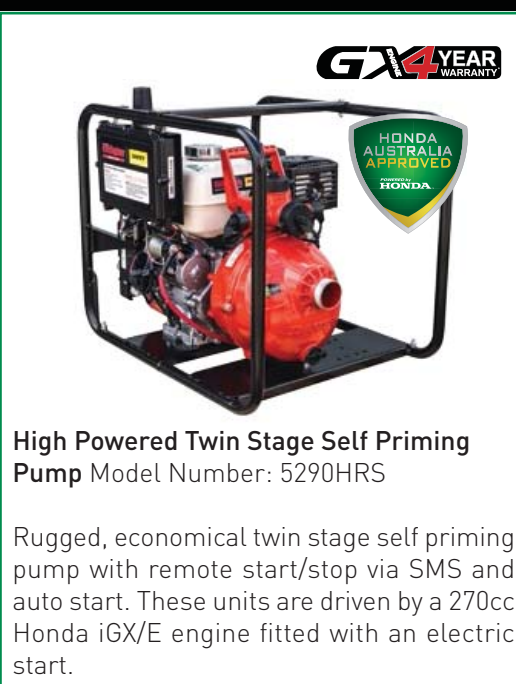

## High Powered Twin Stage Self Priming Pump Model Number: 5290HRS

Rugged, economical twin stage self priming pump with remote start/stop via SMS and auto start. These units are driven by a 270cc Honda iGX/E engine fitted with an electric start.









PRICES EXCLUDE GST

T: (08) 9362 6811

63

F: (08) 9361 3263

# PUMPING SPARES

ITEM CODE	DESCRIPTION	PRICE	ITEM CODE	DESCRIPTION	PRICE
AGFS1000	STANDARD SKID TO SUIT 800 /1000 TANK		1061	PLASTIC 3/4" LUMP END	
					
AGFS500	STANDARD SKID TO SUIT 500L TANK		YHNP075	PLASTIC RED 3/4" FIRE HOSE NOZZLE	
					
AGFS800C	SKID TO SUIT COMPACT 800L		YHNP100	PLASTIC RED 1" FIRE HOSE NOZZLE	
					
SP1000	REPLACEMENT 1000L TANK		YHNB075	BRASS 3/4" FIRE NOZZLE	
					
SP800	REPLACEMENT 800L TANK		YHNB100	BRASS 1" FIRE NOZZLE	
					
SP500	REPLACEMENT 500L TANK		YHRMN075	3/4" RUBBER MOULDED NOZZLE BRASS	
					
FC800	REPLACEMENT 800L COMPACT TANK		YHRMN100	1" RUBBER MOULDED NOZZLE BRASS	
					
AGHR025	METAL STANDARD HOSE REEL		YHNBV075	3/4" BALL VALVE HOSE NOZZLE BRASS	
					
AGHRC019	HOSE REEL SUIT COMPACT UNITS		YHNBV100	1" BALL VALVE HOSE NOZZLE BRASS	
					
YBVML3150	3 WAY BRASS BALL VALVE L PORT		YHNAS100	BLUE ANKA NOZZLE 3/4"	
YBVMT3150	3 WAY STAINLESS BALL VALVE T PORT		YHNAS150	BLUE ANKA NOZZLE 1"	
YBVMF100	METAL BALL VALVE 1"		YHNPJ100	RED POWERJET NOZZLE 1"	
					
YBVMF150	METAL BALL VALVE 1 1/2"		YHNPJ150	RED POWERJET NOZZLE 1 1/2"	
					
YBVMF200	METAL BALL VALVE 2"		<b>BIC COUPLINGS</b>		
					
YLE075	BRASS 3/4" LUMP END				
					

THREAD SIZE	BRASS	ALUMINIUM	PRICE
<b>BIC MALE X FEMALE BSP</b>			
1.1/2"	BIC-BR-A038	BIC-AL-A038	
2"	BIC-BR-A050	BIC-AL-A050	
2.1/2"	BIC-BR-A063	BIC-AL-A063	

PRICES EXCLUDE GST

T: (08) 9362 6811

64

F: (08) 9361 3263



# PUMPING SPARES

## BIC COUPLINGS *continued*

	THREAD SIZE	BRASS	ALUMINIUM
<b>BIC FEMALE x HOSE TAIL</b> 	1.1/2"	BIC-BR-C038	BIC-AL-C038
	2"	BIC-BR-C050	BIC-AL-C050
	2.1/2"	BIC-BR-C063	BIC-AL-C063
<b>BIC FEMALE x FEMALE BSP</b> 	1.1/2"	BIC-BR-D038	BIC-AL-D038
	2"	BIC-BR-D050	BIC-AL-D050
	2.1/2"	BIC-BR-D063	BIC-AL-D063
<b>BIC MALE x HOSE TAIL</b> 	1.1/2"	BIC-BR-E038	BIC-AL-E038
	2"	BIC-BR-E050	BIC-AL-E050
	2.1/2"	BIC-BR-E063	BIC-AL-E063
<b>BIC MALE x MALE BSP</b> 	1.1/2"	BIC-BR-F038	BIC-AL-F038
	2"	BIC-BR-F050	BIC-AL-F050
	2.1/2"	BIC-BR-F063	BIC-AL-F063
<b>BIC CAP (FEMALE)</b> 		BIC-BR-CAP	BIC-AL-CAP
<b>BIC CAP (FEMALE)</b> 		BIC-BR-CAP	BIC-AL-CAP
<b>BIC WASHER BUNA</b> 		BIC-BUNA-WASH	
<b>UNITED FIRE SAFETY NOZZLES</b> 			
THREAD SIZE	PART NUMBER	MATERIAL	COLOUR
3/4"	618-040	POLYCARBONATE	RED
1"	618-050	POLYCARBONATE	RED
1.1/2"	618-055	POLYCARBONATE	RED
1.1/2"	618-045	PVC	GREEN
1.1/2"	618-056	BRONZE	BRONZE

## BLACKOUT NOZZLES



THREAD SIZE	PART NUMBER	MATERIAL	COLOUR
3/4"	FD20		
1"	FD25		
1 1/2"	FD38		

## HEAVY DUTY WASHDOWN GUNS

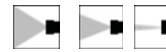

THREAD SIZE	PART NUMBER	COLOUR
1/2"	618-000	BLUE
1/2"	618-000-S	RED

## GARDEN WASHDOWN GUNS



12MM	618-026
18MM	618-027

## BRASS VALVE DIRECTOR



3/4"	618-095
1"	618-096

## FIRE NOZZLE DIRECTOR



3/4"	618-G20
------	---------

ORDER NO	DESCRIPTION	SPECIFICATIONS
<b>STRIKER FIRE MONITORS</b>		
STKR38	STRIKER 38MM FIRE MONITOR	316 STAINLESS, SEALS NITRILE SYNTHETIC RUBBER
STKR50	STRIKER 50MM FIRE MONITOR	316 STAINLESS, SEALS NITRILE SYNTHETIC RUBBER
<b>MASTER STREAM NOZZLES</b>		
STKR818	ALLOY NOZZLE	170 L/MIN @ 100 PSI
STKR819	ALLOY NOZZLE	475 L/MIN @ 100 PSI
STKR820	ALLOY NOZZLE	1325 L/MIN @ 100 PSI
STKR820BC	BRONZE NOZZLE	1325 L/MIN @ 100 PSI

PRICES EXCLUDE GST

T: (08) 9362 6811

65

F: (08) 9361 3263

# ACCUFIRE FIRE UNITS

ACCUFIRE flamethrowers are small, utility mounted flamethrowers that enable farm, forest and rangeland managers to efficiently ignite large tracts of target flammable vegetation quickly, safely and remotely from the cabin of a utility vehicle.

## ACCUFIRE FOREST FIRELIGHTER ACCFF

Used by land managers whose focus is on routine hazard reduction burning of flammable forest vegetation and rangeland grass vegetation.

Let ACCUFIRE introduce you to comfort, speed and efficiency with:

- In-cab switch control for fire on / fire off
- Quick-tatch to utility dropside/frame mount
- Obstacle flick past spring loaded swingarm
- Compact size for convenient lifting and locating
- Ambidextrous for LH or RH drive
- Adjustable angle depending on speed or cast distance
- Operates in forward and reverse
- Auxiliary long range fuel tank as standard
- Fuel and gas efficient
- Hands free, stress free



## ACCUFIRE BROADACRE FIRELIGHTER ACCBF

Popular with Australia's farmland managers whose focus is on the removal of windows, chaff heaps and residual stubble material with harvest weed seed management in mind.

Let ACCUFIRE introduce you to comfort, speed and efficiency with:

- In-cab switch control for fire on / fire off (windows up, no more dead arm)
- Quick-tatch to utility dropside
- Fast ground speed capability
- Fuel and gas efficient
- Operates in forward and reverse
- Hands free, stress free
- Long range on board igniting capability

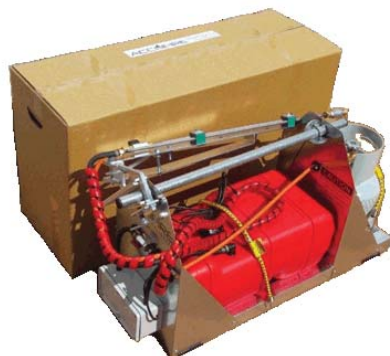

## SPARE PARTS

PRODUCT	DESCRIPTION
FUEL TANK	A boat fuel tank stores the liquid accelerant used for the combustable fuel source.
GAS BOTTLE	A propane filled gas bottle is used as the storage vessel for the firelighters ignition fuel.
PUMP	An electrical pump and solenoid assembly is used to apply the flow and stop mechanism to the liquid accelerant.
CHASSIS	The chassis of the firelighter houses the key components of the firelighter.
SWINGARM AND CLAMP	The swingarm is the mounting apparatus for 2 stainless steel lances and directs the pipes approximately 30 to 40cm off the ground. The first pipe carries the liquid accelerant, the second carries the propane gas. The Clamp mounts the swingarm to the side of the utility vehicle.

\$1,950

PRICES EXCLUDE GST

T: (08) 9362 6811

66

F: (08) 9361 3263

# ELIDE FIRE EXTINGUISHING BALL

## FIRE EXTINGUISHING BALL

- The extinguishing device that saves lives and prevents property damage.

**ELIDE FIRE BALL** prevents fire from spreading. In most situations, when the chemical chain reaction is not stopped quickly the flames grow and accumulate both strength and power, and may result in an increase in danger to human life and property damage.

**ELIDE FIRE EXTINGUISHING BALL** is designed for immediate use. Simply roll or toss it into the fire from a safe distance. Those first critical 20 - 90 seconds are crucial in extinguishing a fire before it becomes uncontrollable and spreads.

- Compact, lightweight, safe and easy to use
- 5 year manufacturer guarantee
- Automatic operation 24/7
- Fast and effective results
- No annual maintenance and service needed
- Ecological and environmentally friendly



**PART NO. FEB01    \$149.00 inc GST**

### THE ELIDE FIRE BALL CAN HANDLE DIFFERENT TYPES OF FIRES:

CLASS A: Ordinary combustible materials such as paper, cloth, wood, rubber, plastic and so on.

CLASS B: Flammable liquid substances such as gasoline, diesel, alcohol, tar, etc.

CLASS C : Electrical – All electrical fire where the electrical component may be either passive or active, such as electrical equipment, fuses, computers, power sources, etc.

CLASS D: Gas – all flammable gases.

CLASS E: Metallic – light metals such as magnesium, lithium and aluminum and their compounds.



### ENVIRONMENTALLY FRIENDLY MATERIAL

The Elide Fire Ball contains dry fire extinguishing powder – ammonium phosphate mono (about 94% active material) – it is a dry chemical fire extinguisher, environmentally friendly and safe for humans, plants and animals.

### THE REVOLUTIONARY ELIDE FIRE BALL

The Elide Fire Ball is a scientifically-proven and effective self-activating fire extinguishing solution for virtually any situation where there is the possibility of an accidental fire. It can be in the home, the office, car, factory, boat, restaurant...in fact, it can be anywhere!

**How does it work?** There are 2 options: If you happen to be near the fire when it starts, simply toss the Elide Fire Ball on to the fire or roll it towards the fire as soon as possible. It will activate within 3-10 seconds and disperse non-toxic chemicals to extinguish the fire. The second option is to position the Elide Fire Ball over or close to the potential source of the fire, such as a stove, an electrical circuit board, a meter box or a computer, using the specially-designed stand that comes with each unit. It will activate automatically by self-detonating when it comes into contact with the fire, even if no-one is around. (You certainly can't do that with a fire extinguisher or a fire blanket!).

### LIGHTWEIGHT BUT DEADLY TO FIRES!

The patented, internationally-acclaimed award-winning Elide Fire Ball is lightweight (1.3kg) and easy to use, even by children and the elderly. There is no training needed and unlike the average fire extinguisher it is service and maintenance-free for five years.

### SAFETY IS OUR NUMBER ONE PRIORITY!

Unlike a fire blanket or fire extinguisher, you don't have to be close to the fire to activate the Elide Fire Ball. Unlike a fire blanket or fire extinguisher, you don't even have to be present when a fire starts! This is because the Elide Fire Ball will self-detonate when it comes into contact with a flame.

PRICES EXCLUDE GST

**T: (08) 9362 6811**

**67**

**F: (08) 9361 3263**

# HOUSEHOLD PUMPS

## Torrium2 Controlled Systems



### Davey XP with Torrium2

- Robust and compact
- Single stage jet assisted pump
- Suitable for use on small to average sized single storey homes

MODEL NO	kW (P <sub>2</sub> )	INLET/ OUTLET	MAXIMUM FLOW	MAXIMUM PRESSURE	TORRIUM2
XP45T	0.45	1"(F) / 1"(M)	45LPM	320k PA	TT45



### Davey HP with Torrium2

- Robust and compact
- Whisper quiet operation
- Strong even pressure for medium to large single or multistorey homes

MODEL NO	kW (P <sub>2</sub> )	INLET/ OUTLET	MAXIMUM FLOW	MAXIMUM PRESSURE	TORRIUM2
HP45-05T	0.55	1¼"(F) / 1"(M)	70LPM	330 kPA	TT45
HP-65-06T	0.60	1¼"(F) / 1"(M)	100LPM	330 kPA	TT45
HP85-08T	0.80	1¼"(F) / 1"(M)	140LPM	330 kPA	TT45



### Davey HS with Torrium2

- Low power consumption, quiet and compact
- Four stage centrifugal pump for high pressure domestic applications
- Ideal for medium to large size single and multistorey homes

MODEL NO	kW (P <sub>2</sub> )	INLET/ OUTLET	MAXIMUM FLOW	MAXIMUM PRESSURE	TORRIUM2
HS50-06T	0.60	1¼"(F) / 1"(M)	80LPM	470 kPA	TT70
HS60-08T	0.76	1¼"(F) / 1"(M)	110LPM	490 kPA	TT70



### Davey XJ with Torrium2

- Robust and compact, single stage jet assisted pump
- Designed for medium to large size, single and multistorey homes
- Suitable for use on a variety of water qualities

MODEL NO	kW (P <sub>2</sub> )	INLET/ OUTLET	MAXIMUM FLOW	MAXIMUM PRESSURE	TORRIUM2
XJ50T	0.56	1"(F) / 1"(M)	50LPM	450 kPA	TT45
XJ70T	0.80	1"(F) / 1"(M)	70LPM	480 kPA	TT70
XJ90T	1.10	1¼"(F) / 1"(M)	90LPM	450 kPA	TT45

PRICES EXCLUDE GST

T: (08) 9362 6811

68

F: (08) 9361 3263

# WATER DISINFECTION

## AquashieldMAX Pressure Boosting and Treatment Packages

- Three stage treatment process for tankwater supplies with flows up to 70LPM.
- Provides pressure boosting and control, two stage pre-filtration down to 1 micron and UV disinfection in a conveniently packaged system.
- Optional fan pack recommended to assist with cooling for high temperature or non-ventilated spaces.  
Easily retrofits onto existing Aquashield systems.
- Provides 30mJ/cm<sup>2</sup> at 90% or above UV Transmission (UVT)



SELECTING A SYSTEM			
Pressure	Outlets	Single Water Source With Torrium Controller	Dual Water Source With RainBank Controller
Standard Pressure Up to 500 kPa	Up to 70LPM	ASHS60-08T	ASHS60-08RB
Premium Pressure Up to 700 kPa	Up to 70LPM	ASHM60-10T	ASHM60-10RB

MODEL NO	APPLICATION	kW (P <sub>2</sub> )	INLET/OUTLET	MAX. HEAD	PRICE
ASHS60-08T	Medium pressure with Torrium2 for single water source	0.76	1 1/4" / 1"	30m	\$4,450
ASHM60-10T	Higher pressure with Torrium2 for single water source	0.94	1 1/4" / 1"	38m	\$4,675
ASHS60-08RB	Medium pressure with RainBank for mains backup	0.76	1 1/4" / 1"	30m	\$4,450
ASHM60-10RB	Higher pressure with RainBank for mains backup	0.94	1 1/4" / 1"	38m	\$4,675

### Option

PART NO	DESCRIPTION	PRICE
32722	Optional cool touch fan pack, for high temperature environments or non ventilated spaces. Suits 50 and 70 litre per minute Aquashield systems	\$385

## Aquashield Centurion UV System

- Proven three stage treatment process for rain tank water supplies with flows up to 70LPM.
- Pre-assembled wall mount unit including two stage Filterpure prefiltration down to 1 micron, followed by Davey Steriflo UV
- Flexibility to install with an existing pump or to a Davey home water pressure system.
- Water flow left to right or right to left, for installation flexibility.
- Provides 30mJ/cm<sup>2</sup> at 90% or above UV Transmission (UVT)



MODEL NO	DESCRIPTION	FLOW RATE	PRICE
ASC50	2 X 10 inch jumbo housings, 20 & 1 micron filtration with 50lpm steriflo	50lpm	\$1,780
ASC70	2 X 10 inch jumbo housings, 20 & 1 micron filtration with 70lpm steriflo	70lpm	\$1,895

PRICES EXCLUDE GST

T: (08) 9362 6811

69

F: (08) 9361 3263



# WATER DISINFECTION

## Steriflo UV Disinfection

- Stage 1** is a 20 micron coarse filter that removes solids larger than 20 microns and provides protection for second and third stages.
- Stage 2** is a fine 1 micron filter that removes small solids and cysts such as Giardia and Cryptosporidium.
- Stage 3** is an Ultraviolet disinfection lamp that sterilises viruses and bacteria.

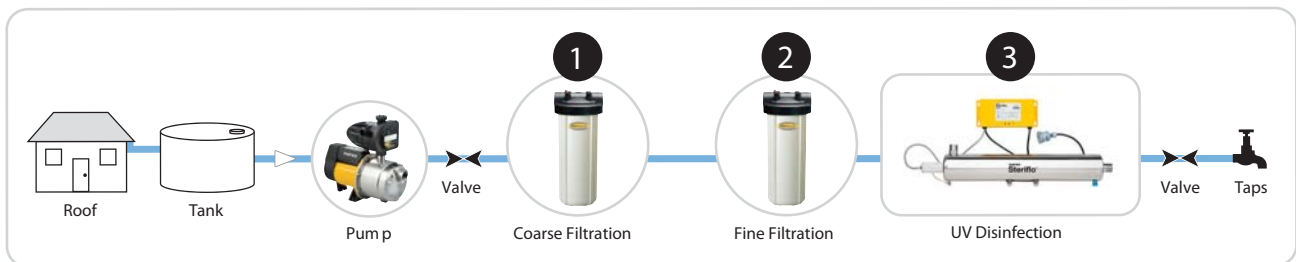

## Steriflo and Filterpure Kits

- Includes UV chamber and two stage filtration and housings. Pump lead included on UV50 & UV70 models.
- Supplied as individual components for installation flexibility.
- Whole house systems offered in 50, 70 and 130lpm options for medium to large homes and light commercial applications.
- Lamp Replacements - Life of 9,000 hours, replace every 12 months.
- Provides 30mJ/cm<sup>2</sup> at 90% or above UV Transmission (UVT)

PART NO	DESCRIPTION	INLET / OUTLET	PRICE
KUV50	UV50, 50lpm kit with 2 x 10" jumbo housings, 1 x 20 micron pleated filter, 1 x 1 micron spun filter	3/4" F / 1" M	\$1,560
KUV70	UV70, 70lpm kit with 2 x 10" jumbo housings, 1 x 20 micron pleated filter, 1 x 1 micron spun filter	3/4" F / 1" M	\$1,725
KUV130	UV130, 130lpm kit with 4 x 10" jumbo housings, 2 x 20 micron pleated filter, 2 x 1 micron spun filter	1 1/2" F / 1 1/2" M	\$2,830

## Davey Steriflo



- Davey Steriflo is an economical means of managing bacteria and virus in drinking water supplies.
- Davey recommend installing prefiltration to ensure the highest penetration of UV light.
- A large range of models are available to suit most applications.
- Provides 30mJ/cm<sup>2</sup> at 90% or above UV Transmission (UVT)

MODEL NO	DESCRIPTION	INLET / OUTLET	PRICE
UV23	23lpm to suit very small homes	3/4" NPT (M) / 3/4" NPT (M)	\$595
UV50	50lpm Steriflo to suit small to medium homes	3/4" BSP (M) / 3/4" BSP (M)	\$1,185
UV70	70lpm Steriflo to suit medium to large homes	1" BSP (M) / 1" BSP (M)	\$1,325
UV130	130lpm Steriflo to suit large homes or commercial properties	1 1/2" BSP (M) / 1 1/2" BSP (M)	\$2,155
UV250	250lpm Steriflo to suit light commercial applications	2" BSP (M) / 2" BSP (M)	\$3,475

PRICES EXCLUDE GST

T: (08) 9362 6811

70

F: (08) 9361 3263

# DELMHORST MOISTURE METERS

Hay growers rely on Delmhorst hay moisture meters to produce top-quality hay with optimum nutritional value and reduced risks of mold growth and spoilage. Delmhorst offers a variety of hay moisture meters to check hay in the windrow, during the baling process, and in the bale.

## F-2000

The F-2000 is great for hay producers looking to enhance quality control. The F-2000 checks hay moisture in the windrow or in bales, and comes with the same accuracy and clarity as the FX-2000!

### Product Features

- Bright, clear digital display.
- Averages up to 100 accumulated readings.
- Displays average and highest of accumulated readings.
- Moisture Range: 6%-40% on hay.
- Built-in calibration check.
- Audible, adjustable alarm alerts you when a pre-selected MC has been reached.
- Size: 8" x 3" x 1 5/8".
- Weight: 10 oz.
- Rugged construction ensures years of reliable use.
- Optional sturdy plastic carrying case.
- 9V battery.
- 3-year warranty.



**Individual Instrument: Part No: F2000**

**Deluxe 18" Package: Part No: F2000K**

Includes meter, H-4 handle, 830-3 18" probe and carrying case.

## FX-2000

This state-of-the-art meter is ideal for high-volume producers who need the time-saving convenience of on-the-go monitoring. Whether in the windrow, on-the-go while baling, or in the bale, the FX-2000 gives clear, accurate moisture readings every step of the way!

### Product Features

- Bright, clear digital display.
- Can be used for on-the-go moisture monitoring or as a portable meter.
- In continuous mode:
  - Takes two readings every second.
  - Displays the average and highest of eight accumulated readings.
  - Readings updated every 4 seconds.
  - Built-in back light.
  - Connects to tractor power supply.
- In portable mode:
  - Averages up to 100 accumulated readings.
  - Displays average and highest of accumulated readings.
- Moisture Range: 6%-40% on hay.
- Built-in calibration check.
- Audible, adjustable alarm alerts you when a pre-selected MC has been reached.
- Size: 8" x 3" x 1 5/8".
- Weight: 10 oz.
- Rugged construction ensures years of reliable use.
- Optional sturdy plastic carrying case.
- 9V battery.
- 3-year warranty.



**Individual Instrument: Part No: FX2000**

**Deluxe 18" Package: Part No: FX200K**

Includes meter with power supply, 1986 bale sensor with cable and mounting bracket, H-4 handle, 830-3 18" probe, and carrying case.

PRICES EXCLUDE GST

**T: (08) 9362 6811**

**71**

**F: (08) 9361 3263**

# DELMHORST MOISTURE METERS SPARES

Delmhorst offers a wide assortment of accessories known throughout the industry for their durability. All Delmhorst electrodes fit any Delmhorst moisture meter.

## FX-2000 ELECTRODES



### 1235

10" prod used for testing standard bales. Attaches directly to the connector on top of the meter. Also available in 18" length as 1235/18.

## FX-2000 ELECTRODES



### 831 Short Pin Prod

For testing hay in the windrow (requires H-4 Handle).



### 1986 Bale Sensor

For continuous monitoring during baling. Comes with 30' cable to run from the sensor mounted in the bale chamber to the meter in the cab. May be used with any model, but is recommended to use with Model FX-2000.

Also available as 1986/40 with 40' cable for larger balers.



### H-4 Handle

Electrode handle that attaches to the built-in connector on the top of any moisture meter. Can be used with the 830 series prods, 831 short pin disc shaped prod, and 832 long pin disc shaped prod. This is useful for large or high density bales of hay or scrap paper. Two handed operation is recommended over using a prod that connects directly to the top of the meter (like our 1235 series) to minimize stress placed on the meter casing.



### 830 Series

Prods for testing standard and high density bales (requires H-4 Handle). Available as:

830-2 - 10" prod

830-3 - 18" prod

830-4 - 36" prod

830-5 - 12" for hops



### 2110

Split bale chamber sensor for use with Freeman balers.

PRICES EXCLUDE GST

T: (08) 9362 6811

72

F: (08) 9361 3263

# DELMHORST MOISTURE METERS SPARES

Delmhorst offers a wide assortment of accessories known throughout the industry for their durability. All Delmhorst electrodes fit any Delmhorst moisture meter.

## FX-2000 ACCESSORIES

---



### 1985

The 1985 is a replacement 30ft coaxial cable for the 1986 bale chamber sensor. Also available in 36ft and 40ft lengths as 1985/36 and 1985/40 respectively.

---



### 1986/EXTENSION

Extends mounting bolts used when installing 1986 bale chamber sensor. Used for newer balers with thick chamber walls.

---



### 315ACC-0003

This kit includes the power supply cable and mounting hardware necessary to install the FX-2000 in your tractor cab.

---

## FX-2000 ACCESSORIES

---



### 324CAS-0065 Carrying Case

This carrying case may be purchased as a part of one of our deluxe moisture meter packages, and fits all prods except the 1986 bale sensor, 830-3 prod, and 830-4 prod. Can also be purchased separately.

---



### MCS-4

This moisture content standard is great for verifying that your F-series hay moisture meter is in calibration. With two electrical resistance values (16% and 22%) to test your meter against, you can be sure that your readings will stand up to the strictest standards of accuracy. The MCS-4 is also available with a letter of certification traceable to NIST.

---

PRICES EXCLUDE GST

T: (08) 9362 6811

73

F: (08) 9361 3263

# TAPEX TWINE - SISAL

CODE	PRODUCT / BRAND	COLOUR	LENGTH / PACK	SPOOLS / PACK	PACKS / PALLET
<b>HIGH DENSITY TWINES</b>					
160210	TAPEX HERCULES® HD	BLUE	2200M	2	24
K089459	KINNEARS SUPREME HD	PINK	2000M	2	24
<b>LARGE SQUARE TWINES</b>					
160850	TAPEX TITAN®	BLUE/YELLOW	2500M	2	24
160204	TAPEX TROJAN®	YELLOW	2200M	2	24
<b>SMALL SQUARE</b>					
160331	TAPEX PREMIUM BLUE	BLUE	4400M	2	32
160102	TAPEX PREMIUM GOLD	GOLD	4400M	2	32
K080975	KINNEARS CONTRACTOR	PINK	4200M	2	40
160340	HAY PRESS	BLUE	2200M	2	32
183002	TAPEX SISAL BALER	GREEN	2700M	2	48
<b>ROUND BALE</b>					
K085000	KINNEARS BIG ROLL	PINK	12000M	2	40
183001	TAPEX SISAL SILAGE	NATURAL	5000M	2	60
183000	TAPEX SISAL BINDER	NATURAL	4400M	2	48



PRICES EXCLUDE GST

T: (08) 9362 6811

74

F: (08) 9361 3263



# NET WRAP - RONDOTEX™

The Tapex Group are proud to be the distributors of RKW Rondotex™ netwrap in Australasia.

Rondotex Evolution™ has been a popular net wrap choice in Australia for more than 20 years. Suitable for wrapping hay, straw and silage, the 1.3m width means you get optimal bale coverage.

RONDOTEX EVOLUTION™ is made with the highest quality raw materials and production standards to achieve excellent net properties such as tensile strength, uniform winding consistency and guaranteed length. All RONDOTEX EVOLUTION™ rolls come with handles for ease of lifting and loading, and all cores are reinforced for improved strength.

- Optimum bale coverage
- High net breaking strength.
- Guaranteed length.
- Red end warning.
- Core identification code for tracking.
- UV protected for Australian conditions.
- Lifting handles.



CODE	PRODUCT / BRAND	COLOUR	WIDTH / ROLL	LENGTH / ROLL	ROLLS / PALLET
160471	RKW™	WHITE, RED EDGE	1.23M	2100M	20
160473	RKW™	WHITE, RED EDGE	1.3M	2100M	20
160472	RKW™	WHITE, RED EDGE	1.23M	3150M	28
160474	RKW™	WHITE, RED EDGE	1.3M	3150M	28



PRICES EXCLUDE GST

T: (08) 9362 6811

75

F: (08) 9361 3263

# GRAIN STORAGE - GRAINFLEX

## Tougher - Safer- More Flexible.

Latest technology seven layer grain tubes made from a combination of remarkable new polymers, Grain-Flex® Tubes are suitable for all human and animal grain applications, and performs well within modern high capacity grain bag extractors. You can fill these 100% recyclable bags in the field, so they will save you time, labour, storage and fuel costs.

- 7 Layer technology.
- Developed to fit 2.75m (9ft) diameter grain loaders.
- Exceptional puncture & tear resistance.
- UV protected for Australian conditions.
- Easy to install.
- Manufactured to strict ISO9001 QA standards from seven-layered co-extruded polythene film using only high quality performance resins and additives.



CODE	PRODUCT / BRAND	COLOUR	WIDTH	LENGTH	GAUGE	ROLLS / PALLET
GFHART975	GRAIN FLEX	WHITE	2.75M (9FT)	75M	250UM	4 OR 6



PRICES EXCLUDE GST

T: (08) 9362 6811

76

F: (08) 9361 3263



# GRAIN BAGGING

Storing your grain in bags during a busy harvest is a great alternative to silo storage and/or freight.

Grain bags are manufactured from polyethylene through a three or five-layer co-extrusion process, each layer with different and specific properties. These layers are melted, thus producing a single uniform film, inseparable and with great resistance. The polyethylene is 100% virgin resin, to ensure quality and consistency throughout the film. Additives such as titanium dioxide and UV stabilizers are added to the white (external) layer and a high concentration of carbon black is added to the black (internal) layer.

## Advantages of storing in grain bags

- A very low cost per tonne of stored grain.
- It allows you to classify the stored grains regarding its quality and commercial identity (Quality Assurance Control).
- The capacity of the storage facilities is remarkably increased.
- It enables you to increase the operative capacity of harvesting.
- Easy sampling of grains stored by means of a conventional sampler.
- High-priced freights during harvest season can be avoided.

## This process provides the following important properties

- Mechanical resistance: e.g. Perforation resistance
- Thermal resistance
- Good stretching
- Internal temperature stability
- Impermeability
- Reflection of solar rays
- Filtration of ultraviolet rays
- Durability
- Flexibility
- Softness
- Internal opacity to block out the sunlight



The Grainvault bag is a new design 5 layer bag that is available in 75, 90 and 100 metre lengths.







PRICES EXCLUDE GST

T: (08) 9362 6811

77

F: (08) 9361 3263

# BALER CHAINS

PART NO	DESCRIPTION	SUITS
621FB 	NEW HOLLAND 845 FLOOR CHAIN DRIVES USA BALER CHAIN CA550-052- C5E-17-1R/OFF-1FLAT The 845 Baler features 6 x chains for serial numbers below 4133874 and 7 x Chains for serial number 413385 and above	NEW HOLLAND 845 Baler
625FB 	NEW HOLLAND 846 847 FLOOR CHAIN DRIVES USA BALER CHAIN CA550-044- C5-15-1R/OFF-1FLAT The 846 Baler and 847 Balers feature 7x Floor chains in a full set.	NEW HOLLAND 846 and 847 Baler
628FB 	NEW HOLLAND 851 852 FLOOR CHAIN DRIVES USA BALER CHAIN CA550-047- C5E-W/WB6-16-1R/OFF- The 851 Baler and 852 Balers feature 8 x Floor chains in a full set.	NEW HOLLAND 851 and 852 Baler
632UB 	DRIVES BALER APRON CHAIN NEW HOLLAND 850 BALER CA550-072- U17-72-71R/OFF-1D/OF This chain comes as a complete set of two (2) chains and are matched length. All packed in one box. 216 links x 72 attachments.	NEW HOLLAND 850 Baler
660UB 	DRIVES BALER APRON CHAIN NEW HOLLAND 846 847 BALER CA550- 063-U17-63-62R/OFF-1D/OF This chain comes as a complete set of two (2) chains and are matched length. All packed in one box. 189 links x 63 attachments.	NEW HOLLAND 846/847 Baler
670UB 	DRIVES BALER APRON CHAIN NEW HOLLAND 851 852 BALER CA557- 078-U16-78-77R/OFF-1D/OF This chain comes as a complete set of two (2) chains and are matched length. All packed in one box. 234 links x 78 attachments.	NEW HOLLAND 851/852 Baler
686UB1 	DRIVES BALER APRON CHAIN NEW HOLLAND 855 BALER 696374 100(2)100-155-U15-52-1COTT This chain comes as a complete set of two (2) chains and are matched length. All packed in one box.	NEW HOLLAND 855 Baler through to serial number 696374

PRICES EXCLUDE GST

T: (08) 9362 6811

78

F: (08) 9361 3263

# BALER CHAINS

PART NO	DESCRIPTION	SUITS
694UB2 	<p>DRIVES BALER APRON CHAIN NEW HOLLAND BALER 848 714629+ CA557-170-U16-57-1CO</p> <p>This chain comes as a complete set of two (2) chains and are matched length. All packed in one box. 228 links x 57 attachments.</p>	NEW HOLLAND 848 Baler from serial number 714628 onwards
698UB 	<p>DRIVES BALER APRON CHAIN NEW HOLLAND 853 BALER CA557-185- U16-62-1CO</p> <p>This chain comes as a complete set of two (2) chains and are matched length. All packed in one box. 248 links x 62 attachments.</p>	NEW HOLLAND 853 Baler
634UB 	<p>DRIVES BALER APRON CHAIN REPAIR SECTION NEW HOLLAND 851 852 BALER</p> <p>Features and benefits of each assembly include; OEM Quality, Manufactured by Drives USA, Individually packed, Chain repair sections available. These chains are packed as single units and can be purchased individually or as a complete set.</p>	NEW HOLLAND round balers



PRICES EXCLUDE GST





T: (08) 9362 6811

79

F: (08) 9361 3263





# SERVICE EXCHANGE GEARBOXES

PART NO	DESCRIPTION	SUITS
SEG1010 	CASE IH MOWER GEARBOX A86518543	DCX131, DCX131F, DCX161, DC132, DC132F, DC162, DC162F
SEG1020 	CASE IH SWIVEL GEARBOX 700713871	DC162, DC132, DCX161, DC515, 8312, 8315
SEG1030 	AFH207196 Replaces John Deere OEM nos AFH204883, AFH202245	John Deere 448, 449, 458, 458F, 459, 468, 468F, 469, 558, 568
SEG1010 	NEW HOLLAND MOWER GEARBOX A86518543	H7450, H7550, H7460, H7560, 1431,1432, 1441, 1442, 2331, 2332

\* These are replacement parts only. Not OEM. Original parts numbers are used for reference only.

# HAY FORKS

	PART NO	DESCRIPTION	SUITS
<b>STRAIGHT TINES</b>			
	B84007	820mm (32")	Conus II type M28 Fixing nut
	B84008	980mm (38 1/2")	
	B84009	1100mm (43")	
	B84010	1240mm (49")	
	B84012	1400mm (55")	Conus III type M33 x 2 Fixing nut
<b>CURVED TINE</b>			
	B84011	600mm (24")	Curved Grab Tine. Conus I Keyed Type
<b>WELD-IN MOUNTING SLEEVES</b>			
	B84101	Conus II type 57mm (2 1/4") Outside diameter	
	B84103	Conus III type 80mm (3.149") Outside diameter	
	B84102	Special Conus I type 50mm (1.968") Outside diameter	
<b>REPLACEMENT MOUNTING NUT</b>			
	B84106	Nut 28mm (1.125") thread dia fits Conus II type. Fits LATE TYPE BLUE LINE spikes	
	B84014	Nut fits Conus III TYPE BLUE LINE spikes	

PRICES EXCLUDE GST

T: (08) 9362 6811

80

F: (08) 9361 3263

# SPARE PARTS

	PART NO	DESCRIPTION	APPLICATION
<b>SITREX</b>			
	AS6001	Wheel Right Hand for Sitrex type Wheel Rake	SITREX
	AS6002	Wheel LEFT Hand for Sitrex type Wheel Rake	SITREX
	AS6010	Tine for Sitrex type Wheel Rake - "A" = 27.5cm	SITREX
<b>TEAGLE</b>			
	AT6010	Yellow 7.1mm	
<b>VICON</b>			
	AA6001	Wheel - Tines Offset - Dished = 93345	ACROBAT
	AV6001	Wheel - Tines Flat = 2299060	SPRINTMASTER
	AV6001	Wheel Right Hand = 2299060	V8, V10, V12 + All Flat Wheel "V" Rakes
	AV6002	Wheel Left Hand = 2299061	
	AV6010	Tine "A" = 30cm Twisted Hook = 92611 (40 per wheel)	ACROBAT
	AV6012	Tine "A" = 25cm Flat Hook = 36133 (40 per wheel)	SPRINTMASTER + "V" Rakes
<b>WILKINSON</b>			
	AW6010	Silver 6.3mm	
	AW6012	Green 7.1mm	
	AW6020	Wilkinson Wheel Ring	

PRICES EXCLUDE GST

T: (08) 9362 6811

81

F: (08) 9361 3263

# DRAPER FRONT BELTING



ORDER NO	MODEL APPLICATION	DETAILS	PRICE
<b>Agco</b>			
Side Belting	(Sold per foot)		
ASBAG41	All Agco Draper Fronts	41" wide - no V guide	\$26 per ft
ASBAG41A	Agco Draper Fronts 9250 Series	41" Wide - V guide on edge	\$31 per ft
ASBAG41B	Agco Draper Fronts 5200 Series	41" Wide - V guide inset 100mm	\$31 per ft
Connector	(Sold as a Kit)		
ABCAG41	Suits 41" side belting	Includes Bolts and Nuts	\$43
Centre Feed Belt	(Sold as a Kit to exact size with joining holes pre punched and includes a Connector Kit)		
AFBAG60	Agco Draper Fronts	60" wide by 57½" long - no V guide	\$560
AFBAG51	Agco Draper Fronts 9250	51.5" wide by 63" long – with V guide	\$510

## Claas

ASBCL395	Maxflo 1050 (35t), 1200 (40t) - Side Belting	1020mm wide with V guide	\$30
----------	--	--------------------------	------

## Honeybee also sold as New Holland

Side Belting	(Sold per foot)		
ASBHB42	All Honeybee - New Holland to approx 2009	42" wide - no V guide	\$26 per ft
ASBHB4175	Honeybee - New Holland 2009 on	41.75" wide - with V guide	\$30 per ft
ASBMD416	Honeybee - 4000 Series 2015 on (Airflx)	41.6" wide - with V guide	\$32 per ft
Connector	(Sold as a Kit)		
ABCHB42	Suits 41¾ " and 42" side Belting	Includes Bolts and Nuts	\$52
ABCHB69	Suits 69" Centre Belt	Includes Bolts and Nuts	\$90

\* These are replacement parts only. Not OEM. Original parts numbers are used for reference only.



PRICES EXCLUDE GST

T: (08) 9362 6811

82

F: (08) 9361 3263

# DRAPER FRONT BELTING



ORDER NO	MODEL APPLICATION	DETAILS	PRICE
----------	-------------------	---------	-------

Honeybee also sold as New Holland

Centre Feed Belts	(Sold as a Kit to exact size with joining holes pre punched and includes a Connector Kit)		
AFBHB34	Honeybee - New Holland - Some early (2 required per machine)	34" wide - no V guide	\$200 ea
AFBHB68	Honeybee - New Holland 2009 on	68.75" wide by 63" long - with V guide	\$540
AFBHB69	Honeybee - New Holland to approx 2009	69" wide by 65" long - no V guide	\$500
AFBHB4175	Honeybee - New Holland 2009 on (2 required per machine)	41.75" wide - with V guide	\$375

John Deere

Side Belting	(Sold per foot)		
ASBJD36	930D, 936D Draper Fronts	36" wide - with V guide	\$27 per ft
ASBJD395	630D, 635D, 640D Draper Fronts	39.5" wide - with V guide	\$30 per ft
Connector	(Sold as a Kit)		
ABCJD36	Suits 36" wide belting	Includes Bolts and Nuts	\$52
ABCJD395	Suits 39 1/2" wide belting	Includes Bolts and Nuts	\$52
ABCJD55	Suits 55.3" wide centre belt	Includes Bolts and Nuts	\$63
ABCJD60	Suits 60" wide centre Belt	Includes Bolts and Nuts	\$68
Centre Feed Belts	(Sold as a Kit to exact size with joining holes pre punched and includes a Connector Kit)		
AFBJD60	930D, 936D Draper Fronts	60" wide by 63 1/2" long - with V guide	\$460
AFBJD553	630D, 635D, 640D Draper Fronts	55.3" wide by 58" long - with V guide	\$430

\* These are replacement parts only. Not OEM. Original parts numbers are used for reference only.

PRICES EXCLUDE GST

T: (08) 9362 6811

83

F: (08) 9361 3263



# DRAPER FRONT BELTING



ORDER NO.	MODEL APPLICATION	DETAILS	PRICE
<b>Midwest</b>			
Side Belting	(Sold per foot)		
ASBMW36	All Midwest Draper Fronts	36" wide - with centre V guide	\$28 per ft
Connector	(Sold as a Kit)		
ABCJD36	All 36" wide belting	Includes Bolts and Nuts	\$52
Centre Feed Belts	(Sold as a Kit to exact size with joining holes pre punched and includes a Connector Kit)		
AFBMW44	Suit Midwest with narrow body centre design	44" wide – with V guide	\$340
AFBMW60	Suit Midwest with wide body centre design	60" wide – with V guide	\$420

## Case/New Holland

Centre Feed Belt			
AFBCNH42	Suits NH800 Series CIH31 Series (OEM 84289411)	42" wide	\$620



## Macdon also sold as Case-IH and New Holland

Side Belting	(Sold per foot)		
ASBMD416	All Macdon prior D60 and Case-IH prior to 2152, 2162	41.6" wide - with V guide	\$32 per ft
ASBMD416DG	D60, D65, FD75 Macdon series 2152, 2162 Case-IH, 83C New Holland	41.6" wide - with double V guide	\$68 per ft
ASBMD415	Early Case-IH swather, Agware swather	41.5" wide - no V guide	\$26 per ft
ASBHB42	Case-IH swathers – 8120 on, some Hesston and Versatile	42" wide - no V guide	\$26 per ft
Connector	(Sold as a Kit)		
ABCMD416	Suits 41 1/2", 41.6" side belting	Includes Bolts and Nuts	\$52
ABCHB42	Suits 42" side belting	Includes Bolts and Nuts	\$52
Centre Feed Belts	(Sold as a Kit to exact size with joining holes pre punched and includes a Connector Kit)		
AFBMD374	Macdon, Case-IH	37.4" wide by 85 3/4" long - with V guide	\$360
AFBMD384	Macdon, Case-IH	38.4" wide by 97" long - with V guide	\$390
AFBMD415	Macdon, Case-IH	41.5" wide by 85 3/4" long - with V guide	\$520

\* These are replacement parts only. Not OEM. Original parts numbers are used for reference only.

PRICES EXCLUDE GST

T: (08) 9362 6811

84

F: (08) 9361 3263

# DRAPER FRONT BELTING



ORDER NO.	MODEL APPLICATION	DETAILS	PRICE
-----------	-------------------	---------	-------

**Macdon also sold as Case-IH and New Holland continued**

AFBMD454	Macdon, Case-IH	45.4" wide by 97" long - with V guide	\$400
AFBMD549	Macdon, Case-IH	54.9" wide by 85¾" long - with V guide	\$470
AFBMD559	Macdon, Case-IH	55.9" wide by 97" long - with V guide	\$500
AFBMD595	Macdon, Case-IH	59.5" wide by 85¾" long - with V guide	\$600
AFBMDDG-IV	Macdon, Case-IH, 83C New Holland	78.5" wide by 63¾" long - with single V guide	\$650

**Honeybee Feed Belt Rollers & Hydraulic Motors**

AHBDR05	Side Belt Driving Roller Honeybee & New Holland (including Bearing) suits 42" Belting		\$475
AHBDR10	Side Belt Idler Roller Honeybee & New Holland (including 2 Bearings) suits 42" Belting		\$425
AHBHB	Hexagonal Bearing suits Roller		\$45
AHBHM40	OMP40 Hydraulic Motor suits Honeybee & New Holland Belt Fronts		\$745
AHBHM50	OMP50 Hydraulic Motor suits Honeybee & New Holland Belt Fronts		\$760

**Macdon Feed Belts & Hydraulic Motors**

AMDDR-3962	Side Belt Driving Roller Macdon & Case-IH Belt Fronts 960, 962, 1040, 1042, (No Bearings). Original Part: 113962		\$490
AMDIR-3320	Side Belt Idler Roller Macdon & Case-IH Belt Fronts 960, 962, 1040, 1042, 2042 includes Roller Part 43320 and Shaft Part 49056 (No Bearings)		\$450
AMDDR-3837	Side Belt Driving Roller Macdon & Case-IH Belt Fronts 972, 973, 1052, 2052. Original Part: 113837 (No Bearings)		\$490
AMDIR-0081	Side Belt Idler Roller Macdon & Case-IH Belt Fronts 972, 973, 1052, 2052 includes Roller Part 100081 and Shaft Part (No Bearings)		\$450
AMDDR-2205	Drive Roller to suit Case-IH 8820		
AMDIR-2042	Idler Roller to suit Case-IH 8820	\$430	
AMDDR-3965	Drive Roller to suit Macdon 3000	\$420	
AMDDR-4696	Side Belt Driving Roller Macdon & Case-IH & New Holland D60, 2152, 83C. Original Part: 174694		\$490
AMDIR-4714	Side Belt Idler Roller Macdon & Case-IH & New Holland D60, 2152, 83C. Original Part: 17417		\$300
AMDHM05	Hydraulic Motor suits Macdon & Case-IH Belt Fronts (4 bolt mount)		\$670
AMDLAG	Lagging Kit for one Roller (3 pieces per roller)		\$125

**John Deere**

AJDDR36	Side Belt Driving Roller inc Hex Bearings Suit 936 Draper, Original Part: AH212964	\$515
AJDHB	Hexagonal Bearing - Suit Draper Front Rollers	\$60
AJDIR-36	Side Belt Idler Roller, Suit 936 Draper, Original Part: H213230, H160572	\$415

\* These are replacement parts only. Not OEM. Original parts numbers are used for reference only.

PRICES EXCLUDE GST

T: (08) 9362 6811

85

F: (08) 9361 3263

# PICKUP BELTS



ORDER NO	MODEL DESCRIPTION AND DETAILS	PRICE
<b>Case-IH</b>		
PBCIHBO	Belt suits 1015, 403, 503, 21¾" wide 601/8" long – (No Teeth Fitted)	\$150
PBSMFB	Front belt suits 2015 model, 18¾" wide 57¾" long – (No Teeth Fitted)	\$110
PBSMRB	Rear belt suits 2015 model, 18¾" wide 57¾" long	\$100

## John Deere

PBJDBO	Belt suits 110, 132, 212, 214, 912, 914, 3 Roller Models 22" wide 66½" long – (No Teeth Fitted)	\$150
PBJDBO5	Belt with holes 44½" wide x 57¼" long suits JD615P (No Teeth Fitted)	\$230

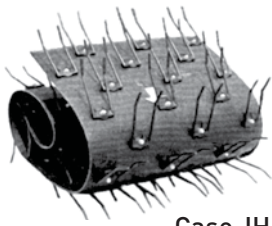

Case-IH



Phillips Swathmaster



Teeth

## Phillips Swathmaster

PBSMFB	Front belt suits late model with ¼" cleats. 18¾" wide 57¾" long – (No Teeth Fitted) 42 Teeth per Belt	\$110
PBSMRB	Rear belt suits late model with ¼" cleats. 18¾" wide 57¾" long	\$100
PBSMJNR	Flat Joiner Strip incl Bolts and Nuts	\$20
PBSMFBW	Front belt suits late model "Rollerdown" 37¾" wide 57¾" long (No teeth fitted)	\$335

## Victory

PBVICFB1	Front Belt 17½" wide x 44¼" long replaces Part No. 01290-110001 – (No Teeth Fitted)	\$110
PBVICRB1	Rear Belt 17½" wide x 44¼" long replaces Part No. 01300-110002	\$105
PBVICFB2	Front Belt 17½" wide x 53½" long replaces Part No. 720010 – (No Teeth Fitted)	\$110
PBVICRB2	Rear Belt – Plain Belt 17½" wide x 53½" long replaces Part No. 013005-110003	\$140

## Teeth

PBTEETH-SP	Single Prong Teeth Victory	\$1
PBTEETH-DP	Double Prong Teeth suits Case-IH, John Deere, Smales, Swath Master, Allis	\$1.80
PBBN	Bolt and Nut suits double prong teeth ¾" (No fangs)	\$0.50
PBSPBN	Bolt and Nut – suits single prong teeth 1" (No fangs)	\$0.75
PBJB	Bolt and Nut – to join ends of Pick Up Belts ¾" (With fangs)	\$1.75



\* These are replacement parts only. Not OEM. Original parts numbers are used for reference only.

PRICES EXCLUDE GST



T: (08) 9362 6811



86

F: (08) 9361 3263

# SPARE PARTS





## DE ENGINEERS

ITEM CODE	DESCRIPTION	PRICE
AD8010	45 degree gearbox	\$635.00
		
AD8020	Uni joint	\$95.00
		
AD8011	Input/output pinion gear shaft 14 tooth	\$95.00
		

ITEM CODE	DESCRIPTION	PRICE
AD8012	Input/output pinion gear shaft 14 tooth	\$105.00
		
AD8013	Input/output pinion gear shaft 20 tooth	\$110.00
		

## MOYLAN

ITEM CODE	DESCRIPTION	PRICE
E4001665000000	Double universal joint	\$368.00
		
E6001665000000	Double universal joint	\$402.00
		
T6010NC12000	PTO shaft 11 inch	\$365.00
		
T800960NC12000	PTO shaft 15 inch	\$472.00
		

ITEM CODE	DESCRIPTION	PRICE
AM8010	Bearing housing	\$15.75
		
AM8011	40mm Bearing adaptor sleeve	\$29.60
		
AM8012	35mm shaft	\$11.30
		
DG59035SF	Simol trailer jack	\$134.40
		

PRICES EXCLUDE GST

T: (08) 9362 6811

87

F: (08) 9361 3263



# TIPPER TRAILER KITS



## BRONZE

<b>TKBRONZESHORT</b> YBZ5-E2.5D1W2/WUCAERCA  4TG-E90*800QZ  THKSG2.0M	<b>Short Bronze Kit</b> HPU 12V 2.5cc 10L SSH SLV RCA 12V Standard 1.5kW Motor 2.5cc Pump 10L Steel Square Horizontal Reservoir Solenoid Lowering Valve 3m Pendant Break Away  Cylinder Telescopic UB C Ball 2B 4ST 110D 800STR 4 Stage 800mm Stroke  Tipper Hose Kit Bronze 2M 2 x Nipple 3/8" BSPPM x 9/16" JICM Elbow Swivel 90° BSPPM x JICM 1/2" x 9/16" Hose Assembly 2m x 3/8" c/w Hose Ends 9/16" JICF	\$1,575.00
<b>TKBRONZELONG</b> YBZ5-E2.5D1W2/WUCAERCA 6TG-E105*1000QZ  THKSG2.0M	<b>Long Bronze Kit</b> HPU 12V 2.5cc 10L SSH SLV RCA Cylinder Telescopic UB C Ball 2B 6ST 125D 1000STR 6 Stage 1000mm Stroke  Tipper Hose Kit Bronze 2M	\$1,850.00
<b>TKBRONZEXLONG</b> YBZ5-E2.5D1W2/WUCAERCA 6TG-E120*1250QZ  THKSG2.5M	<b>Extra Long Bronze Kit</b> HPU 12V 2.5cc 10L SSH SLV RCA Cylinder Telescopic UB C Ball 2B 6ST 145D 1250STR 6 Stage 1250mm Stroke  Tipper Hose Kit Bronze 2.5M Hose Assembly 2.5m x 3/8" c/w Hose Ends 9/16" JICF	\$2,075.00

## SILVER

<b>TKSILVERSHORT</b> YBZ5-E2.5D1W2/WUCAERCABL-I3.2  4TG-E90*800QZ  THKSG2.0M	<b>Short Silver Kit</b> HPU 12V 2.5cc 10L SSH SLV RCA 11LPM 12V Standard 1.5kW Motor, 2.5cc Pump, 10L Steel Square Horizontal Reservoir, Solenoid Lowering Valve, 11 LPM Flow Control, 3m Pendant Break Away  Cylinder Telescopic UB C Ball 2B 4ST 110D 800STR 4 Stage, 800mm Stroke  Tipper Hose Kit Silver 2M 2 x Nipple 3/8" BSPPM x 9/16" JICM Elbow Swivel 90° BSPPM x JICM 1/2" x 9/16" Hose Assembly 2m x 3/8" c/w Hose Ends 9/16" JICF Hose Burst Valve 3/8"	\$1,625.00
<b>TKSILVERLONG</b> YBZ5-E2.5D1W2/WUCAERCABL-I3.2 6TG-E105*1000QZ  THKSG2.0M	<b>Long Silver Kit</b> HPU 12V 2.5cc 10L SSH SLV RCA 11LPM Cylinder Telescopic UB C Ball 2B 6ST 125D 1000STR 6 Stage, 1000mm Stroke  Tipper Hose Kit Silver 2M	\$1,900.00
<b>TKSILVERXLONG</b> YBZ5-E2.5D1W2/WUCAERCABL-I3.2 6TG-E120*1250QZ  THKSG2.5M	<b>Extra Long Gold Kit</b> HPU 12V 2.5cc 10L SSH SLV RCA 11LPM Cylinder Telescopic UB C Ball 2B 6ST 145D 1250STR 6 Stage 1250mm Stroke  Tipper Hose Kit Silver 2.5M Hose Assembly 2.5m x 3/8" c/w Hose Ends 9/16" JICF	\$2,125.00

PRICES EXCLUDE GST

T: (08) 9362 6811

88

F: (08) 9361 3263

# TIPPER TRAILER KITS



## GOLD

<b>TKGOLDSHORT</b>	<b>Short Gold Kit</b>	
YBZ5-E2.5D1W2/WUCHETORCABL-I3.2	HPU 12V 2.5cc 10L SSH SLV MO TO RCA 11LPM 12V 1.5kW Motor c/w Thermal Overload 2.5cc Pump 10L Steel Square Horizontal Reservoir Solenoid Lowering Valve c/w Manual Override 11 LPM Flow Control 3m Pendant Break Away	
4TG-E90*800QZ	Cylinder Telescopic UB C Ball 2B 4ST 110D 800STR 4 Stage 800mm Stroke	\$1,700.00
THKSG2.0M	Tipper Hose Kit Gold 2M 2 x Nipple 3/8" BSPPM x 9/16" JICM Elbow Swivel 90° BSPPM x JICM 1/2" x 9/16" Hose Assembly 2m x 3/8" c/w Hose Ends 9/16" JICF Hose Burst Valve 3/8"	
<b>TKGOLDLONG</b>	<b>Long Gold Kit</b>	
YBZ5-E2.5D1W2/WUCHETORCABL-I3.2 6TG-E105*1000QZ	HPU 12V 2.5cc 10L SSH SLV MO TO RCA 11LPM Cylinder Telescopic UB C Ball 2B 6ST 125D 1000STR 6 Stage 1000mm Stroke	\$1,975.00
THKSG2.0M	Tipper Hose Kit Gold 2M	
<b>TKGOLDXLONG</b>	<b>Extra Long Gold Kit</b>	
YBZ5-E2.5D1W2/WUCHETORCABL-I3.2 6TG-E120*1250QZ	HPU 12V 2.5cc 10L SSH SLV MO TO RCA 11LPM Cylinder Telescopic UB C Ball 2B 6ST 145D 1250STR 6 Stage 1250mm Stroke	\$2,200.00
THKSG2.5M	Tipper Hose Kit Gold 2.5M Hose Assembly 2.5m x 3/8" c/w Hose Ends 9/16" JICF	

PRICES EXCLUDE GST

T: (08) 9362 6811

89

F: (08) 9361 3263

# TIPPER INSTALLATION KITS

## BRONZE

TIKB 160414 VH2-38/61	Kit Tipper Installation Bronze Hinge Trailer L&R Pair Cable Battery Black Pair 380 & 610mm	\$220.00 1 pair 1 pair
-----------------------------	--	------------------------------

## SILVER

TIKS 160414 160130 VH2-38/61	Kit Tipper Installation Silver Hinge Trailer L&R Pair Pads Deck Trailer Pair Cable Battery Black Pair 380 & 610mm	\$270.00 1 pair 1 pair 1 pair
---------------------------------------	--	--

## GOLD

TIKG 160414 160130 VH2-38/61 RCA-2B3LW	Kit Tipper Installation Gold Hinge Trailer L&R Pair Pads Deck Trailer Pair Cable Battery Black Pair 380 & 610mm Wireless Remote Control SA 2 Button	\$580.00 1 pair 2 pairs 1 pair 1 assembly
--	---	---

## INDIVIDUAL COMPONENTS

160414	Hinge Trailer L&R Pair	\$160.00
160130	Pads Deck Trailer Pair	\$56.00
VH2-38	Cable Battery Black 380mm	\$32.00
VH2-61	Cable Battery Black 610mm	\$40.00
RCA-2B3LW	Wireless Remote Control SA 2 Button	\$260.00



PRICES EXCLUDE GST

T: (08) 9362 6811

90

F: (08) 9361 3263

# HYDRAULIC POWER UNITS



<b>Bronze</b> YBZ5-E2.5D1W2/WUCAERCA	HPU 12V 2.5cc 10L SSH SLV RCA	\$860.00
<b>Bronze – 6L Round Reservoir</b> YBZ5-E2.5BC1W2/WUAAERCA	HPU 12V 2.5cc 6L SRH SLV RCA	\$810.00
<b>Silver</b> YBZ5-E2.5D1W2/WUCAERCABL-I3.2	HPU 12V 2.5cc 10L SSH SLV RCA 11lpm	\$885.00
<b>Gold</b> YBZ5-E2.5D1W2/WUCHETORCABL-I3.2	HPU 12V 2.5cc 10L SSH SLV MO TO RCA 11lpm	\$925.00
<b>Gold – 15L Reservoir</b> YBZ5-E2.5GA1W2/WUCHETORCABL-I3.2	HPU 12V 2.5cc 15L SSH SLV MO TO RCA 11lpm	\$975.00
<b>Pendants</b> RCA-2B3L3M-B RCA-2B3LW	Pendant SA 2 Button 3M Lead Wireless Remote Control SA 2 Button	\$70.00 \$260.00
<b>Dust Cover</b> YBZ-DJZK-01	Cover Dust Std DC Motors	\$25.00



# HOSE ASSEMBLY KITS

<b>Bronze</b> THKB2.0M THKB2.5M	Tipper Hose Kit Bronze 2M Tipper Hose Kit Bronze 2.5M	\$140.00 \$160.00
<b>Silver / Gold</b> THKSG2.0M THKSG2.5M	Tipper Hose Kit Silver / Gold 2M Tipper Hose Kit Silver / Gold 2.5M	\$160.00 \$180.00
<b>Hose Burst Valve</b> VUBA02 CFFVRD02	Valve Hose Burst Cartridge 3/8" Valve Inline Body for 3/8" VUBA Cartridge	\$25.00 \$40.00



PRICES EXCLUDE GST

T: (08) 9362 6811

91

F: (08) 9361 3263



# HYDRAULIC MOTORS

## APPLICATION

- Conveyors
- Feeding mechanism of robots and manipulators
- Metal working machines
- Textile machines
- Agriculture machines
- Food industries
- Grass cutting machinery etc.

## OPTIONS

- Model- Spool valve, gerotor
- Flange and wheel mount
- Motor with needle bearing
- Side and rear ports
- Shafts- straight, splined and tapered
- Shaft seal for high and low pressure
- Metric and BSPP ports
- Speed sensing
- Other special features

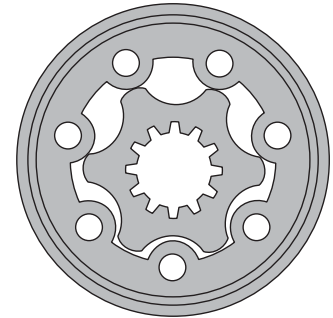

STANDARD: SHAFT 1" STRAIGHT KEYED, MOUNT SAE A 2 BOLT, PORTS 1/2" BSPP CASE 1/4" BSPP

PART NO	CC/REV	ROTOR WIDTH L1-mm	SPEED MAX CONT RPM	FLOW MAX CONT LPM	PRESSURE DROP MAX CONT BAR	INLET PRESSURE MAX CONT BAR	TORQUE MAX CONT Nm	WEIGHT KG
MP 25 COD	25	5.2	1600	40	100	175	33	6.1
MP 32 COD	32	6.3	1560	50	100	175	43	6.1
MP 40 COD	40	7.4	1500	60	120	175	62	6.2
MP 50 COD	49.5	6.67	1210	60	140	175	94	6.3
MP 60 COD	59.5	8.25	983	60	140	175	110	6.3
MP 80 COD	79.2	10.67	755	60	140	175	151	6.4
MP 100 COD	99	13.33	605	60	140	175	193	6.6
MP 125 COD	123.8	16.67	486	60	140	175	237	6.7
MP 160 COD	158.4	21.33	378	60	140	175	313	6.9



PART NO	DESCRIPTION	SUITS	ORIGINAL PART NO
HM1010	MCDON SIDE BELT DRIVE	D60 MCDON	
HM1020	SIDE BELT MCDON	MCDON 1040	CHARLYN 1012088-009
HM1030	SIDE BELT JOHN DEERE	JD 936	JOHN DEERE AH159156
HM1040	CASE 2388 RADIATOR RORARY SCREEN DRIVE	CASE 2388	EATON 1012572009

\* These are replacement parts only. Not OEM. Original parts numbers are used for reference only.

PRICES EXCLUDE GST

T: (08) 9362 6811

92

F: (08) 9361 3263

# HYDRAULICS COUPLER / MOTORS

ORDER NO	SHAFT DIAMETER	MOTOR DIS-PLACEMENT	INPUT FLOW	INPUT PRESSURE	MOTOR SPEED	TORQUE
----------	----------------	---------------------	------------	----------------	-------------	--------

## HYDRAULIC MOTOR

AGHM100C	1 3/8" 6 SPLINE SHAFT STANDARD AGRICULTURAL ASAE SPLINE	100CC 6.2CU IN/REV MAX SPEED CONTINUOUS 748RPM INTERMITTENT 900 RPM	30 LPM	1000 PSI 70 BAR	289 RPM	94 Nm			
				2000 PSI 140 BAR	274 RPM	198 Nm			
				2500 PSI 175 BAR	269 RPM	250 Nm			
			AGHM160C	1 3/8" 6 SPLINE SHAFT STANDARD AGRICULTURAL ASAE SPLINE	160CC 9.6CU IN/REV MAX SPEED CONTINUOUS 470RPM INTERMITTENT 560 RPM	30 LPM	1000 PSI 70 BAR	182 RPM	150 Nm
							2000 PSI 140 BAR	168 RPM	321 Nm
							2500 PSI 175 BAR	164 RPM	380 Nm
AGHM200C	1 3/8" 6 SPLINE SHAFT STANDARD AGRICULTURAL ASAE SPLINE	200CC 12.2CU IN/REV MAX SPEED CONTINUOUS 375RPM INTERMITTENT 450 RPM				30 LPM	1000 PSI 70 BAR	146 RPM	190 Nm
							2000 PSI 140 BAR	140 RPM	399 Nm
							2500 PSI 175 BAR	140 RPM	399 Nm
			AGHM200C	1 3/8" 6 SPLINE SHAFT STANDARD AGRICULTURAL ASAE SPLINE	200CC 12.2CU IN/REV MAX SPEED CONTINUOUS 375RPM INTERMITTENT 450 RPM	50 LPM	1000 PSI 70 BAR	245 RPM	184 Nm
							2000 PSI 140 BAR	240 RPM	395 Nm
							2500 PSI 175 BAR	288 RPM	378 Nm
AGHM200C	1 3/8" 6 SPLINE SHAFT STANDARD AGRICULTURAL ASAE SPLINE	200CC 12.2CU IN/REV MAX SPEED CONTINUOUS 375RPM INTERMITTENT 450 RPM				75 LPM	1000 PSI 70 BAR	465 RPM	138 Nm
							2000 PSI 140 BAR	447 RPM	311 Nm
							2500 PSI 175 BAR	436 RPM	375 Nm
			AGHM200C	1 3/8" 6 SPLINE SHAFT STANDARD AGRICULTURAL ASAE SPLINE	200CC 12.2CU IN/REV MAX SPEED CONTINUOUS 375RPM INTERMITTENT 450 RPM	75 LPM	1000 PSI 70 BAR	369 RPM	160 Nm
							2000 PSI 140 BAR	362 RPM	375 Nm
							2500 PSI 175 BAR	436 RPM	375 Nm



Hydraulic motors used in the agricultural market for driving field bins and other forms of machinery requiring a 6 spline 1 3/8" PTO output shaft.

### Features:

- Roller gear stator
- Output shaft supported by tapered roller bearings
- High pressure motor seals
- Case drain not required
- Cross port relief for pressure spikes

These motors are suitable for continuous operation under rough operating conditions such as high operating pressures, thin oil, or frequent reverse cycling.

# COUPLINGS

ORDER NO	DESCRIPTION	FEMALE	MALE	LENGTH	IMAGE
----------	-------------	--------	------	--------	-------

## BREAKAWAY COUPLINGS

B256		1 3/8" 21 spline	1 3/8" 6 spline	6 1/2" 165mm	
B152	Clamp type	1 3/8" 21 spline	1 3/8" 6 spline	6 1/2" 165mm	
B259	Quick release type				
B2416	Quick release type	1 3/8" 6 spline	1 3/8" 21 spline	6 1/2" 165mm	
B153	Clamp type				
B2459		1 3/4" 20 spline	1 3/8" 6 spline	7" 180mm	
B2460		1 3/4" 20 spline	1 3/8" 21 spline	7" 180mm	
B3725		1 3/4" 6 spline	1 3/8" 6 spline	7" 180mm	
B3726		1 3/8" 6 spline	1 3/4" 20 spline	7" 180mm	

PRICES EXCLUDE GST

T: (08) 9362 6811

93

F: (08) 9361 3263

# HYDRAULIC CYLINDERS

BORE DIAMETER	1.50" 38.10mm	2.00" 50.80mm	2.50" 63.50mm	3.00" 76.20mm	3.50" 88.90mm	4.00" 101.60mm
---------------	------------------	------------------	------------------	------------------	------------------	-------------------

## TECHNICAL SPECIFICATIONS

A +0.15mm +0.20mm	0.75" 19.05	1.00" 25.40	1.00" 25.40	1.00" 25.40	1.00" 25.40	1.00" 25.40
B	1.75" 44.45	2.10" 53.34	2.10" 53.34	2.10" 53.34	2.10" 53.34	2.10" 53.34
C	1.65" 44.91	1.97" 50.04	1.97" 50.04	1.97" 50.04	1.97" 50.04	1.97" 50.04
D	1.25" 31.75	2.00" 50.80	2.00" 50.80	2.00" 50.80	2.00" 50.80	2.00" 50.80
E ±3mm	9.5" 241.30	12.25" 311.15	12.25" 311.15	12.25" 311.15	12.25" 311.15	12.25" 311.15
F	0.875" 22.23	1.25" 31.75	1.50" 38.10	1.50" 38.10	1.75" 44.45	1.75" 44.45
G	3.50" 88.90	5.125" 130.18	5.125" 130.18	5.125" 130.18	5.125" 130.18	5.125" 130.18
H	1.25" 31.75	2.125" 53.98	2.125" 53.98	2.125" 53.98	2.125" 53.98	2.125" 53.98
I	0.46" 11.68	0.71" 18.03	0.71" 18.03	0.71" 18.03	0.71" 18.03	0.71" 18.03
J	0.85" 21.59	1.125" 28.58	1.125" 28.58	1.125" 28.58	1.125" 28.58	1.125" 28.58
K	0.84" 21.34	1.10" 27.94	1.10" 27.94	1.10" 27.94	1.10" 27.94	1.10" 27.94
L	1.875" 47.62	2.75" 69.85	2.75" 69.85	2.75" 69.85	2.75" 69.85	2.75" 69.85
M	0.48" 12.19	0.472" 11.99	0.625" 15.88	0.625" 15.88	0.787" 19.99	0.787" 19.99
N	1.875" 47.63	2.375" 60.33	2.875" 73.03	3.500" 88.90	4.000" 101.60	4.500" 114.30
O	9/16" UNO	9/16" UNO	3/4" UNO	3/4" UNO	3/4" UNO	3/4" UNO
P	4.125" 104.78	4.375" 111.12	4.375" 111.12	4.375" 111.12	4.375" 111.12	4.375" 111.12
Q	0.84" 21.34	0.950" 24.13	0.950" 24.13	0.950" 24.13	0.950" 24.13	0.950" 24.13
R Rod Thread	0.75"-16 UNF	1.25"-12 UNF	1.25"-12 UNF	1.25"-12 UNF	1.25"-12 UNF	1.25"-12 UNF
S ±3mm	10.25" 260.35	12.25" 311.15	12.25" 311.15	12.25" 311.15	12.25" 311.15	12.25" 311.15

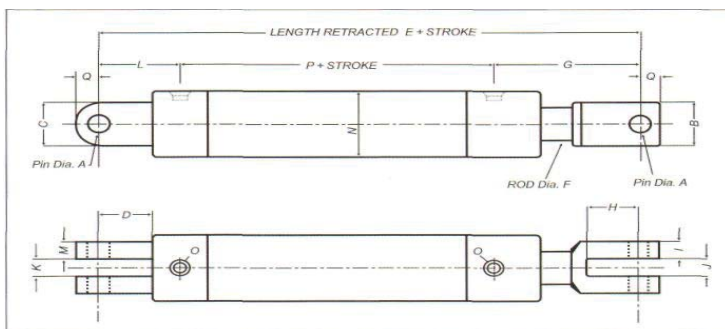

PRICES EXCLUDE GST

ORDER NO	BORE	STROKE	ORDER NO	BORE	STROKE
----------	------	--------	----------	------	--------

## HYDRAULIC CYLINDERS

1506AS	1.5"	6"	2530AS	2.5"	30"
1508AS	1.5"	8"	2536AS	2.5"	36"
1510AS	1.5"	10"	2548AS	2.5"	48"
1512AS	1.5"	12"	3008AS	3"	8"
1516AS	1.5"	16"	3010AS	3"	10"
1518AS	1.5"	18"	3012AS	3"	12"
1520AS	1.5"	20"	3016AS	3"	16"
1524AS	1.5"	24"	3018AS	3"	18"
1530AS	1.5"	30"	3020AS	3"	20"
1536AS	1.5"	36"	3024AS	3"	24"
1548AS	1.5"	48"	3030AS	3"	30"
2006AS	2"	6"	3036AS	3"	36"
2008AS	2"	8"	3048AS	3"	48"
2010AS	2"	10"	3508AS	3.5"	8"
2012AS	2"	12"	3512AS	3.5"	12"
2016AS	2"	16"	3518AS	3.5"	18"
2018AS	2"	18"	3520AS	3.5"	20"
2020AS	2"	20"	3524AS	3.5"	24"
2024AS	2"	24"	3530AS	3.5"	30"
2030AS	2"	30"	3536AS	3.5"	36"
2036AS	2"	36"	3548AS	3.5"	48"
2048AS	2"	48"	4008AS	4"	8"
2506AS	2.5"	6"	4012AS	4"	12"
2508AS	2.5"	8"	4016AS	4"	16"
2510AS	2.5"	10"	4018AS	4"	18"
2512AS	2.5"	12"	4020AS	4"	20"
2516AS	2.5"	16"	4024AS	4"	24"
2518AS	2.5"	18"	4030AS	4"	30"
2520AS	2.5"	20"	4036AS	4"	36"
2524AS	2.5"	24"	4048AS	4"	48"

ORDER NO	DESCRIPTION
----------	-------------

## HYDRAULIC HOSE

4C2AT	1/4" Double Wire Braid
6C2AT	3/8" Double Wire Braid
8C2AT	1/2" Double Wire Braid
12C2AT	3/4" Double Wire Braid
16C2AT	1" Double Wire Braid

T: (08) 9362 6811

94

F: (08) 9361 3263

# SPIRALGUARD

**SpiralGuard®** is a light weight product that is a cost effective way of protecting your hoses and cables from abrasion and impact. Because of the expanding nature of the product it is possible to wrap individual hoses as well as bundles of hoses in a loom. The product has been designed with rounded edges for ease of fitment and no sharp edges means no chance of cutting the hose.

## Key Features

- Exceptional anti-crushing and abrasion resistance
- Suitable for use in temperature ranges of -100° C to +100° C
- Easy to fit – does not cause injury
- U.V. resistant
- Suitable for single or multiple hose bundles
- Can be easily fitted on site without removal of hoses
- Self lubricating to reduce wear on hoses and cables
- Greatly extends the working life of hydraulic hoses
- Distinctive colours and clear printing of the product



## Suitability

Tested to international standards of ISO 6805. MSHA approved to MSHA IC-213/2. Flame retardant SpiralGuard™ can be utilized in a large variety of Industries.

How to calculate quantity:

$$\frac{\text{Outside diameter of hose}}{\text{Inside diameter of SpiralGuard® (mm)}} \times \text{Length (m) of hose to be covered}$$

## Example:

25m length of 40mm diameter hose, select the SpiralGuard® product based on wrapping range SGX-40

$$40 \div 33 = 1.21$$

$$1.21 \times 25 \text{ (mm)} = 30 \text{ metres of SpiralGuard® SGX-40}$$

PART NO	COLOUR	NOMINAL DIA. (inside Dia)	WRAPPING RANGE	HOSE INSIDE DIA.	1-WIRE	2-WIRE	MULTI SPIRAL	DASH SIZE	
SGX-12	BLACK	9	9-13MM	3/16"	✓	-	-	-3	
SGX-16	BLACK	13	13-17MM	1/4"	✓	-	-	-4	
SGX-20	BLACK	16	16-22MM	1/4"	-	✓	-	-4	
SGX-25B	BLACK	21	22-28MM	1/2"	✓	✓	✓	-8	
SGX-25BL	BLUE	21	22-28MM	1/2"	✓	✓	✓	-8	
SGX-25R	RED	21	22-28MM	1/2"	✓	✓	✓	-8	
SGX-25GR	GREEN	21	22-28MM	1/2"	✓	✓	✓	-8	
SGX-25Y	YELLOW	21	22-28MM	1/2"	✓	✓	✓	-8	
SGX-25W	WHITE	21	22-28MM	1/2"	✓	✓	✓	-8	
SGX-25OR	ORANGE	21	22-28MM	1/2"	✓	✓	✓	-8	
SGX-32	BLACK	27	27-33MM	5/8"	✓	✓	✓	-10	
SGX-40	BLACK	33	33-44MM	1"	✓	✓	✓	-16	
SGX-50	BLACK	44	44-65MM	1 1/4"	✓	✓	✓	-20	
SGX-75	BLACK	65	65-90MM	2"	✓	✓	✓	-32	
SGX-90	BLACK	80	HOSE LOOMS 80MM - 200MM						

PRICES EXCLUDE GST

T: (08) 9362 6811

95

F: (08) 9361 3263



# CLUTCHES

ORDER NO	DESCRIPTION	SUITS
<b>HUSKY AUGER CLUTCHES</b>		
4HD-3-1AB-SG-3/4	Clutch 3", 1 AB Section Pulley 3/4" bore	Stationary Motor Clutches
4HD-3 1/2-1A-BW-3/4	Clutch 3 1/2", 1 A Section Pulley 3/4" bore	Stationary Motor Clutches
4HD-4-1AB-BW-3/4	Clutch 4", 1 AB Section Pulley 3/4" bore	Stationary Motor Clutches
4HD-5-1A-BW-3/4	Clutch 5", 1 A Section Pulley 3/4" bore	Stationary Motor Clutches
5HD-4AB-BG-3/4	Clutch 4", 2 AB Section Pulley 3/4" bore	Stationary Motor Clutches
5HD-4-2AB-BG-1	Clutch 4", 2 AB Section Pulley 1" bore	Stationary Motor Clutches
5HD-4-2AB-BG-25	Clutch 4", 2 AB Section Pulley 25mm bore	Stationary Motor Clutches
5HD-4-2AB-BG-11/8	Clutch 4", 2 AB Section Pulley 1 1/8" bore	Stationary Motor Clutches
5HD-4 3/4-2AB-BG-30	Clutch 4 3/4", 2 AB Section Pulley 30mm bore	Stationary Motor Clutches
<b>GO KART CLUTCHES</b>		
5HD-10T-401-1	10 Tooth, 40-1 ASA Pitch 9-20HP 1" bore	Go Kart Heavy Duty
4HD-10T-401-3/4	10 Tooth, 40-1 ASA pitch 1-7HP 3/4" bore	Go Kart Heavy Duty
4HD-12T-351-3/4	12 Tooth, 35-1 ASA Pitch 1-7HP 3/4" bore	Go Kart Heavy Duty
4HD-10T-401-5/8	10 Tooth, 40-1 ASA Pitch 5/8" bore	Go Kart Heavy Duty
4HD-12T-351-5/8	12 Tooth, 35-1 ASA Pitch 5/8" bore	Go Kart Heavy Duty
MAX-10T-401-3/4	10 Tooth, 40-1 ASA Pitch, Maxtorque 3/4" bore	Go Kart Standard
MAX-12T-351-3/4	12 Tooth, 35-1 ASA Pitch, MaxTorque 3/4" bore	Go Kart Standard
MAX-10T-401-5/8	10 Tooth, 40-1 ASA Pitch, MaxTorque 5/8" bore	Go Kart Standard
MAX-12T-351-5/8	12 Tooth, 35-1 ASA Pitch, MaxTorque 5/8" bore	Go Kart Standard



5HD-4-2AB-BG-1



MAX-10T-401-5/8



4HD-10T-401-3/4

PRICES EXCLUDE GST

T: (08) 9362 6811

96

F: (08) 9361 3263



# PTO SHAFTS

COMER NUMBER	SERIES	CROSS DIMENSIONS
180.014.130	4	
180.016.130	6	
180.018.130	8	
180.019.130	9	



COMER NUMBER	SERIES	UNI-CROSS	DIMENSION CLOSED (L) MM	DIMENSION OPEN (L)	TRACTOR END	IMPLEMENT END	RATED HP @ 540 RPM
<b>COMER STANDARD PTO</b>							
T401010ENC12112	4	180.014.130	1010	1569	1 3/8 Z6 COLLAR	1 3/8 Z6 PIN	35
T401410ENC12112	4	180.014.130	1410	2242	1 3/8 Z6 COLLAR	1 3/8 Z6 PIN	35
T401910ENC12112	4	180.014.130	1910	2500	1 3/8 Z6 COLLAR	1 3/8 Z6 PIN	35
T601010ENC12112	6	180.016.130	1010	1569	1 3/8 Z6 COLLAR	1 3/8 Z6 PIN	65
T601410ENC12112	6	180.016.130	1410	2242	1 3/8 Z6 COLLAR	1 3/8 Z6 PIN	65
T601910ENC12112	6	180.016.130	1910	2500	1 3/8 Z6 COLLAR	1 3/8 Z6 PIN	65
T801010ENC12112	8	180.018.130	1010	1550	1 3/8 Z6 COLLAR	1 3/8 Z6 PIN	95
E900660NC15135	9	180.019.130	660		1 3/4 Z20 COLLAR	1 3/4 Z20 PIN	190

### COMER STANDARD PTO WITH SAFETY CLUTCH

T400760ENC12F12	4	180.014.130	760	1116	1 3/8 Z6 COLLAR	1 3/8 Z6	35
T601010ENC12F22	6	180.016.130	1010	1569	1 3/8 Z6 COLLAR	1 3/8 Z6	65
T800910ENC12F42	8	180.018.130	910	1450	1 3/8 Z6 COLLAR	1 3/8 Z6	95

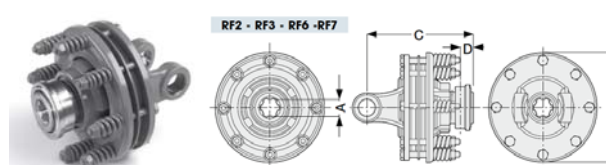
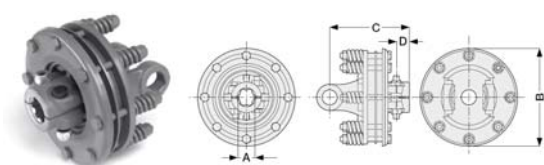

COMER NUMBER	REF	SERIES	A	B (mm)	C (mm)	D (mm)	TORQUE MAX Nm
<b>COMER SAFETY CLUTCH</b>							
146.262.001	F22	6	1 3/8 Z6	195	146	26	1200
146.264.014	F45	6	1 3/4 Z20	195	156	26	1600
146.284.011	F42	8	1 3/8 Z6	195	169	26	2000
146.284.013	F44	8	1 3/4 Z6	195	169	26	2000

### COMER SAFETY / OVER RUN CLUTCH

146.364.001	RF6	6	1 3/8 Z6	195	190	26	1400
146.384.003	RF8	8	1 3/4 Z6	195	203	28	1400
146.384.004	RF8	8	1 3/4 Z20	195	203	28	1400

PRICES EXCLUDE GST



# GEARBOXES

COMER PART NO	ANDLINE PART NO	SUPPLIER	TYPE	RATIO	HP @ 540 RPM	INPUT SHAFT	OUTPUT SHAFT	OUTPUT SHAFT	WEIGHT (KG)
9.124.005.30	AL01910	COMER	L	1: 1	15	25MM	25MM	NA	4.8
9.124.020.10	AL01911	COMER	T	1: 1	15	25MM	25MM	25MM	5
9.124.006.30	AL01915		T	1.9:1	9.5	25MM	25MM	25MM	5
9.124.032.20	AL01918	COMER	T	1:1.9	15	25MM	25MM	25MM	5
9.259.007.20	AL01933	COMER	T	1:1	36	1 3/8 Z6	1 3/8 Z6	1 3/8 Z6	14
9.259.016.30	AL01938	COMER	T	1:1	36	30MM	30MM	30MM	14
9.259.032.30	AL01947	COMER	T	1:1	36	1 3/8 Z6	30MM	30MM	14
9.259.013.00	AL01934	COMER	T	2:1	17	1 3/8 Z6	1 3/8 Z6	1 3/8 Z6	14
9.259.021.00	AL01941	COMER	T	2:1	17	30MM	30MM	30MM	14
9.267.042.00	AL01953	COMER	T	1:1.46	52	1 3/8 Z6	1 3/8 Z6	1 3/8 Z6	21
9.267.023.00	AL01955	COMER	T	1:1.92	30	1 3/8 Z6	1 3/8 Z6	1 3/8 Z6	21
9.267.034.10		COMER	T	1:1.92	30	1 3/8 Z6	35MM	35MM	21
9.267.806.10	AL01952	COMER	T	1:1	55	1 3/8 Z6	1 3/8 Z6	1 3/8 Z6	21
9.267.248.00	AL01956	COMER	T	1.92:1	22	1 3/8 Z6	1 3/8 Z6	1 3/8 Z6	21
	AL01924		T	1:1	90	1 3/8 Z6	1 3/8 Z6	1 3/8 Z6	25
	AL01925		T	1:1.92	58	1 3/8 Z6	1 3/8 Z6	1 3/8 Z6	25
9.301.000.00		COMER	T	1:1	150	1 3/4 Z20	1 3/4 Z20	1 3/4 Z20	61.5
9.331.019.00		COMER	T	1:1	240	1 3/4 Z20	1 3/4 Z20	1 3/4 Z20	105
9.331.006.00		COMER	T	1:1.53	240	1 3/4 Z20	1 3/4 Z20	1 3/4 Z20	105
9.205.805.00	SLASHER	COMER	L	1:1.92	30	1 3/8 Z6	NA	NA	16
9.205.809.00	SLASHER	COMER	T	1:1.92	30	1 3/8 Z6	1 3/8 Z6	NA	16
9.140.804.20	SLASHER	COMER	L	1:1.92	60	1 3/8 Z6	NA	NA	28
9.140.872.00	SLASHER	COMER	T	1:1.92	60	1 3/8 Z6	1 3/8 Z6	NA	28
9.140.811.10	SLASHER	COMER	L	1:1.5	60	1 3/8 Z6	NA	NA	28
9.227.803.00	SLASHER	COMER	L	1:1	75	1 3/8 Z6	NA	NA	38
9.227.801.00	SLASHER	COMER	L	1:1.46	75	1 3/8 Z6	NA	NA	38
9.227.804.00	SLASHER	COMER	L	1:1.83	75	1 3/8 Z6	NA	NA	38
9.266.012.10	SLASHER	COMER	T	1:1.84	90	1 3/8 Z6	1 3/8 Z6	1 3/8 Z6	34
9.285.013.10	SLASHER	COMER	T	1:1.86	125	1 3/4 Z20	1 3/4 Z20	1 3/4 Z20	49.8
9.171.006.00	SLASHER	COMER	T	1:1	150	1 3/4 Z20	1 3/4 Z20	NA	72.5
9.171.007.00	SLASHER	COMER	T	1:1.42	120	1 3/4 Z20	1 3/4 Z20	NA	72.5
9.171.003.00	SLASHER	COMER	L	1:1.93	110	1 3/4 Z20	NA	NA	72.5



PRICES EXCLUDE GST

T: (08) 9362 6811

98

F: (08) 9361 3263

# SIMOL JACKS

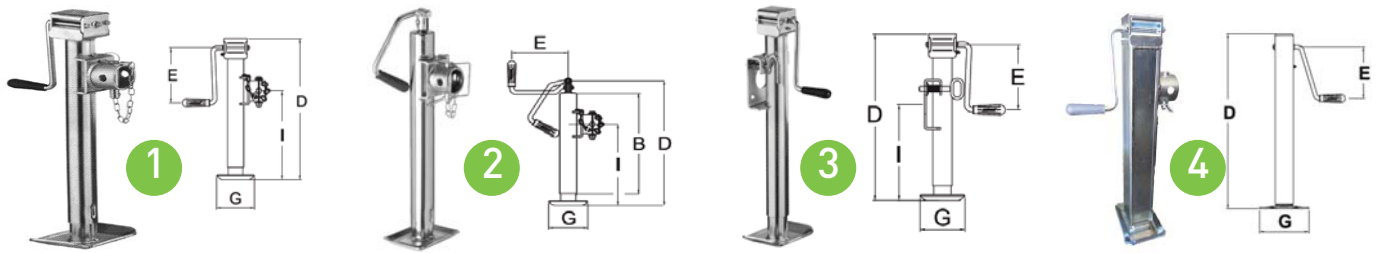

	TYPE	TUBE	SCREW STROKE mm	UNIT kg	MAX STATIC LOAD	B mm	C mm	D mm	E mm	G mm	H mm	I mm
1	LT3103	57	250	6.1	1300			430	168	120x165		280
	LT3153	57	370	7.1	1300			560	168	120x165		405
2	ST3104	57	250	5.4	1300	330		410	168	120x165		265
	ST3154	57	360	6.4	1300	455		535	168	120x165		390
	ST3254	57	360		1300	605		685	168	120x165		580
3	LF3101	57	250	6.3	1300			430	168	120x165		245
	LF3151	57	370	7.3				560	168	120x165		404
4	DG590Z	70	350	8.4	1500			530	175	120x165		

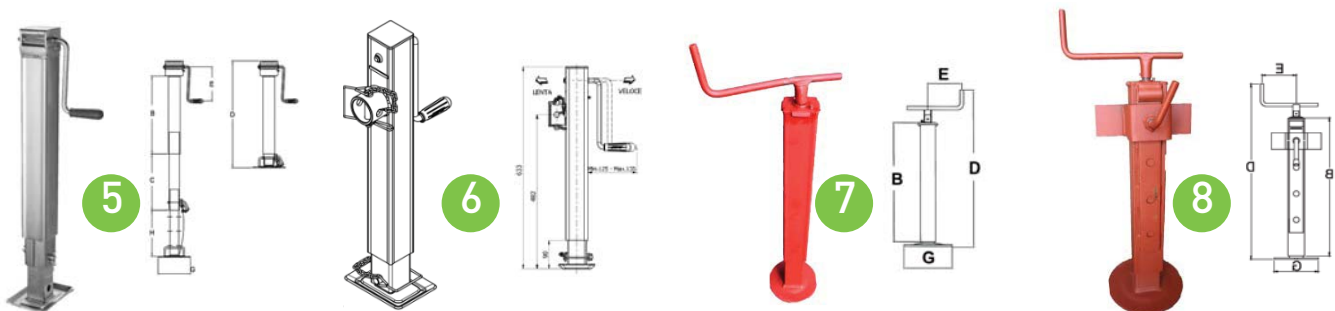

	TYPE	TUBE	SCREW STROKE mm	UNIT kg	MAX STATIC LOAD	B mm	C mm	D mm	E mm	G mm	H mm	I mm
5	DG5903SF	70	370	12.5	1500	460	370	595	170	120x165	340	
6	DG6003SFW (2 SPEED)	70	300	12.3	2000	543	300	633	209	120x165	340	482
7	P560	70	300	8.2	1000	500		670	185	160		
8	PE595	70	300	11.5	1000	500		670	185	160		

PRICES EXCLUDE GST

# SIMOL JACKS

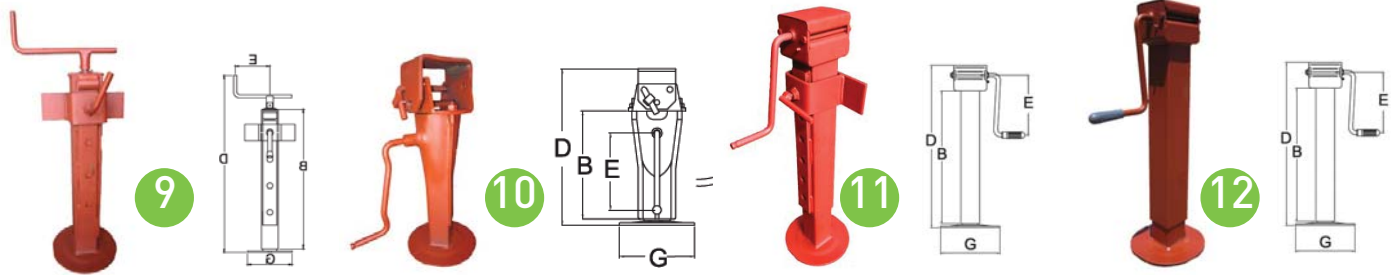

	TYPE	TUBE	SCREW STROKE mm	UNIT kg	MAX STATIC LOAD	B mm	C mm	D mm	E mm	G mm	I mm
9	PE600	80	300	16.6	1200	500		670	185	220	
10	DS510S	70	170	13.8	6000	325	125	460	220	220	415
11	DG706PE	80	300	15.6	4000	500		620	225	220	
12	DG706 DG706W (2 SPEED)	80 80	300 300	13.4 13.4	4000 4000	500 500		620 620	225 225	220 220	

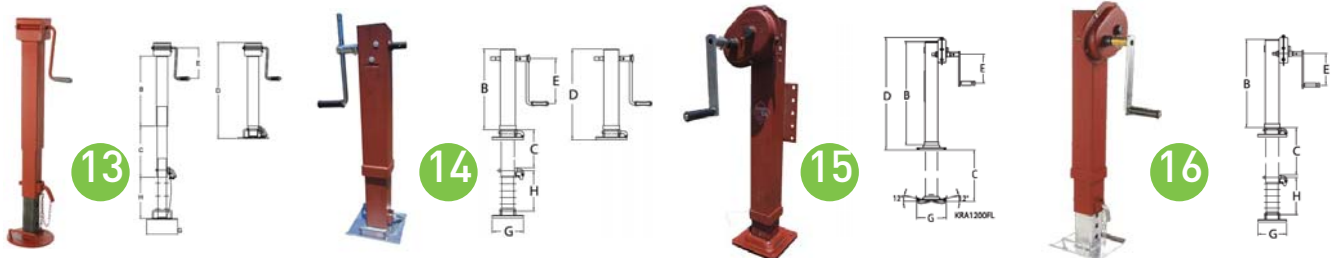

	TYPE	TUBE	SCREW STROKE mm	UNIT kg	MAX STATIC LOAD	B mm	C mm	D mm	E mm	G mm	H mm
13	DG7063SF DG7063FW (2 SPEED)	80 80	300 300	21 21	2500 2500	500 500	290 290	685 685	225 225	220 220	276 276
14	K450	110	310	32	4500	600	310	700	325	250	300
15	KRA1200FL	110	450	45	10000	900	450	980	250	250	
16	KRA750	110	420	43.2	10000	700	420	825	250	250	300

PRICES EXCLUDE GST

T: (08) 9362 6811

100

F: (08) 9361 3263



# PRESSURE CLEANERS

ORDER NO	ENGINE	START	RATING	PUMP	FRAME	SPECIFICATIONS	WEIGHT
<b>PRESSURE CLEANERS</b>							
HB2000	HONDA	RECOIL	5 HP	HAWK PS315G 3450 RPM	FULL ROLL FRAME FOUR MINI WHEELS	11 LITRES @2000 PSI	39 KG
HB2400	HONDA	RECOIL	6.5 HP	HAWK PS315G 3450 RPM	FULL ROLL FRAME FOUR MINI WHEELS	11 LITRES @2400 PSI	41 KG
HB2500	HONDA	RECOIL	9.0 HP	HAWK PS345G 3450 RPM	FULL ROLL FRAME FOUR LARGE WHEELS	14.5 LITRES @2500 PSI	57 KG
HB3000	HONDA	RECOIL	13.0 HP	HAWK PS345G 3450 RPM	FULL ROLL FRAME FOUR MINI WHEELS	15 LITRES @3000 PSI	66 KG
HB3000R	HONDA	RECOIL	13.0 HP	HAWK HC506I REDUCTION BOX 1450 RPM	FULL ROLL FRAME FOUR LARGE WHEELS	15 LITRES @3000 PSI	75 KG
HB3000R-E	HONDA	ELECTRIC	13.0 HP	HAWK HC506I REDUCTION BOX 1450 RPM	FULL ROLL FRAME FOUR LARGE WHEELS	15 LITRES @3000 PSI	100 KG
HB6300R-E	HONDA	ELECTRIC	23.0 HP	HAWK HC650I REDUCTION BOX 1450 RPM	FULL ROLL FRAME ISOLATION MOUNTS FOUR LARGE WHEELS	20 LITRES @3000 PSI	110 KG
HB6900R-E	HONDA	ELECTRIC	27.0 HP	HAWK HC940I REDUCTION BOX 1450 RPM	FULL ROLL FRAME ISOLATION MOUNTS FOUR LARGE WHEELS	26 LITRES @3000 PSI	
HB6340R-E	HONDA	ELECTRIC	23.0 HP	HAWK HC932A REDUCTION BOX 1450 RPM	FULL ROLL FRAME ISOLATION MOUNTS FOUR LARGE WHEELS	20 LITRES @ 4000 PSI	
HB6950R-E	HONDA	ELECTRIC	27.0 HP	HAWK PX17 RE- DUCTION BOX 1450 RPM	FULL ROLL FRAME ISOLATION MOUNTS FOUR LARGE WHEELS	17 LITRES @ 5000 PSI	
HBL100R-E	YANMAR	ELECTRIC	10.0 HP DIESEL	HAWK HC506I REDUCTION BOX 1450 RPM	FULL ROLL FRAME ISOLATION MOUNTS FOUR LARGE WHEELS	15 LITRES @ 3000 PSI	

ALL UNITS ARE SUPPLIED WITH:

- 10 METRE HOSE ASSEMBLY WITH QUICK COUPLINGS
- GUN & SWIVEL
- DOUBLE STAINLESS STEEL LANCE
- DETERGENT INJECTION



HB2000



HB3000R



HB3000R-E



HB6900R-E

ORDER NO	DESCRIPTION
<b>PRESSURE CLEANERS SPARES</b>	
71001.10	10 METRE HOSE ASSEMBLY
71001.15	15 METRE HOSE ASSEMBLY
71001.20	20 METRE HOSE ASSEMBLY
H2404.11ASY	GUN, SWIVEL AND COUPLING
H2617.02ASY	DOUBLE LANCE, NOZZLE & NIPPLE
H2403.48	UNLOADER KIT VBC



HB6340R-E



HBL100R-E

PRICES EXCLUDE GST

T: (08) 9362 6811

101

F: (08) 9361 3263

# GENERATORS

ORDER NO	MAX KVA @0.8PF	CONTINUOUS OUTPUT WATTS	TANK CAPACITY	NOISE LEVEL 1/4 LOAD/7M	WEIGHT (KG)	DIMENSIONS (L x W x H)
----------	----------------	-------------------------	---------------	-------------------------	-------------	------------------------

## YAMAHA SILENT INVERTER GENERATOR

EF1000IS	1.0	900W	2.5L	47 dBA	12.7	450 x 240 x 380
EF2000IS	2.0	1600W	4.4L	51.5 dBA	20	490 x 280 x 445
EF2400IS	2.4	2000W	6.0L	54 dBA	32	527 x 419 x 459
EF3000ISE	3.0	2800W	13L	51 dBA	67	680 x 445 x 555
EF6300ISE	6.3	5500W	17L	58 dBA	91	780 x 616 x 692

## HONDA SILENT INVERTER GENERATOR

EU10i	1.0	900W	2.3L	52 dBA	13	450 x 240 x 380
EU20i	2.0	1600W	4.1L	59 dBA	21	510 x 290 x 425
EU30i	3.0	2600W	7.02L	57 dBA	35.5	622 x 378 x 490



EF1000IS



EF2000IS



EF2400IS



EF3000ISE



EU10i



EU30i

# YAMAHA ACCESSORIES

PART NO	DESCRIPTION	PRICE
---------	-------------	-------

## GENERATOR COVERS

GNCVR-10-0	COVER TO SUIT EF1000IS	\$68.18
GNCVR-20-0	COVER TO SUIT EF2000iS, EF2000iSC	\$72.72
GNCVR-24-0	COVER TO SUIT EF2400IS, EF2800I	\$77.27
GNCVR-30-0	COVER TO SUIT EF3000ISE	\$81.81

## ACCESSORIES

PARALLEL KIT	SUITS EF2400IS & EF2000IS	\$385.00
SECURITY CABLE	SECURITY CABLE WITH KEYS	\$39.00
TROLLEY	FOLDABLE TROLLEY	\$69.00
LUB-10W30	YAMALUBE SAE 10W30	\$18.17
7CF-Y2510-00	WHEEL KIT TO SUIT EF2400IS ONLY	\$331.82
GNRST-30	REMOTE START KIT TO SUIT EF3000ISE WORKS UP TO 10 METRES AWAY	\$877.27
7XF-Y8600-00	REMOTE START KIT TO SUIT EF6300ISE	\$700.00
7VW-Y8720-A0	REMOTE START KIT TO SUIT EF6600E AND EF7200E	\$313.64

PRICES EXCLUDE GST

T: (08) 9362 6811

102

F: (08) 9361 3263

# GENERATORS

ORDER NO	MAX KVA @0.8PF	CONTINUOUS OUTPUT WATTS	ENGINE TYPE	NOISE LEVEL 1/4 LOAD/7M	WEIGHT (KG)	DIMENSIONS (LxWxH)
----------	----------------	-------------------------	-------------	-------------------------	-------------	--------------------

## DUNLITE HONDA GENERATORS

DGUH2.7S-2	3.3	2700W	HONDA GX200	72 dBA	40	650 x 435 x 415
DGUH3.5S-2	4.4	3500W	HONDA GX270	67 dBA	60	735 x 520 x 500
DGUH5S-2	5.8	4800W	HONDA GX340	73 dBA	70	735 x 520 x 500
DGUH6S-2	7.0	5600W	HONDA GX390	69 dBA	75	735 x 520 x 500
DGUH6ES-2	7.0	5600W	HONDA GX390	69 dBA	80	735 x 520 x 500
DGUH7S-2	8.0	6000W	HONDA GX390	76 dBA	80	810 x 520 x 525
DGUH7ES-2	8.0	6000W	HONDA GX390	76 dBA	85	810 x 520 x 525
DGUH9ES-2	9.5	7500W	HONDA GX630	75 dBA	110	876 x 546 x 700
DGUH11ES-2	11.0	8500W	HONDA GX630	75 dBA	110	876 x 546 x 700
DGUH11E-3S-2	12.0	9600/3W	HONDA GX630	75 dBA	130	876 x 546 x 700
DGUH15ES-2	15.0	12000W	HONDA GX690	75 dBA	160	876 x 546 x 700
DGUH16E-3S-2	16.0	12000/3W	HONDA GX690	75 dBA	165	876 x 546 x 700

## DUNLITE DIESEL GENERATORS

DGUKD6.5ES-2	6.5	5200W	KOHLER KD440	89 dBA	100.5	810 x 550 x 560
DGULD6.8ES-2	6.8	5600W	LISTER K172E	80 dBA	110	810 x 545 x 545
DGUYD6.8ES-2	6.8	6000W	YANMAR L100N5	89 dBA	110	810 x 550 x 560
DGUKD8.5ES-2	8.5	7000W	KOHLER 12.5 HP	80 dBA	166	890 x 570 x 720
K-MAX 5	5	4400W	LISTER K172		163	
K-MAX 10	10	8800W	LISTER KV2-80		280	

## DUNLITE HONDA MULTI-POWER PACKS PETROL POWERED

MPP-MINI (RECOIL START)	4.4		HONDA GX270	67 dBA	85	735 x 545 x 525
MPP (RECOIL START)	7.0	6000W	HONDA GX390	69 dBA	110	900 x 870 x 680
MPPE (ELECTRIC START)	7.0	6000W	HONDA IGX390	69 dBA	112	900 x 870 x 680

## MINE SPEC DIESEL GENERATORS

DGUKD6.5ES-MINE	6.5	5200W	KOHLER KD440	89 dBA	158	876 x 546 x 700
DGULD6.8ES-MINE	6.8	5400W	LISTER K172E	80 dBA	165	876 x 546 x 700
DGUYD6.8ES-MINE	6.8	5400W	YANMAR L100N5	80 dBA	165	876 x 546 x 700
DGUKD8.5ES-MINE	8.5	6800W	KOHLER 25LD	80 dBA	172	876 x 546 x 700

## MINE SPEC OPTIONS & ACCESSORIES

WHEEL KIT-400-4	4 WHEELS ATTACHED TO FRAME FOR EASY TRANSPORTATION
80-EARTH STAKE	COPPER EARTH STAKE WITH EARTH CABLE



DGUH3.5S-2



DGUH7S-2



DGUKD6.5ES-2



DGUKD8.5ES-2

PRICES EXCLUDE GST

T: (08) 9362 6811

103

F: (08) 9361 3263

# AIR COMPRESSORS

ORDER NO	DISP CFM	FAD CFM	HP	CYL	TANK (LTR)	WEIGHT (KG)	DIMENSIONS (L x W x H)
----------	----------	---------	----	-----	------------	-------------	------------------------

### WESTAIR 12 / 24 VOLT AIR COMPRESSORS

DC12	4	1.3	0.5	1	N/A	7.5	33 X 12 X 21
DC1208	4	1.3	0.5	1	8	19.5	42 X 38 X 33
DC24	5.5	2.6	0.5	1	N/A	7.5	33 X 12 X 21
DC2408	5.5	2.6	0.5	1	8	19.5	42 X 38 X 33

### WESTAIR BELT DRIVE SINGLE PHASE AIR COMPRESSORS

WE12/54	11.2	8.3	2.2	2	80	69	100 X 38 X 74
WE18/54*	15.1	11.3	3	2	80	82	100 X 38 X 74
WE18/110*	15.1	11.3	3	2	150	127	135 X 46 X 86

### WESTAIR 3 PHASE BELT DRIVE 415VOLT AIR COMPRESSORS

WA20/110	19.2	12.7	4	3	110	140	135 X 40 X 85
WA27/110	26.3	18.0	5.5	2	110	160	135 X 45 X 85
WA35/110	34.0	28.3	7.5	3	110	175	135 X 50 X 100
WA35/200	34.0	28.3	7.5	3	200	220	175 X 50 X 100
WA45/250	42.5	35.8	10	3	250	270	175 X 50 X 100
WA65/250	64.5	52.0	15	4	250	295	175 X 50 X 100

### WESTAIR 3 PHASE BELT DRIVE QUIET CABINET 415VOLT AIR COMPRESSORS

WA25SC	27.8	20.2	5.5	2	N/A	230	80 X 75 X 105
WA35SC	35.1	24.2	7.5	3	N/A	270	80 X 75 X 111
WA45SC	46.5	38.9	10	3	N/A	290	80 X 75 X 111

### WESTAIR 3 PHASE BELT DRIVE QUIET CABINET 415VOLT PACKAGE WITH 190L VERTICAL RECEIVER

WA25SCP	27.8	20.2	5.5	2	N/A	230	80 X 75 X 105
WA35SCP	35.1	24.2	7.5	3	N/A	270	80 X 75 X 111
WA45SCP	46.5	38.9	10	3	N/A	290	80 X 75 X 111



PRICES EXCLUDE GST

T: (08) 9362 6811

104

F: (08) 9361 3263

# AIR COMPRESSORS

ORDER NO	DISP CFM	FAD CFM	ENGINE	CYL	TANK (LTR)	WEIGHT (KG)	DIMENSIONS (LXWXH)
<b>WESTAIR HONDA PETROL AIR COMPRESSORS</b>							
WP20/70	20.2	14.7	GX200	3	68	83	94 X 32 X 76
WP20/110	20.2	14.7	GX200	3	110	128	130 X 45 X 84
WP27/110	28.3	22.1	GX270	2	110	180	130 X 45 X 92
WP27/110ES			GX270				
WP38/110	37.6	29.0	GX390	3	110	190	130 X 45 X 97
WP38/110ES			GX390				
WP48/160	48.1	40.2	GX390	3	160	210	150 X 45 X 109
WP48/160S			GX390				

## WESTAIR KOHLER DIESEL AIR COMPRESSORS

WD20/70	20.2	14.7	KD225	3	70	90	100 X 48 X 75
WD20/120	20.2	14.7	KD225	3	116	130	128 X 46 X 88
WD27/120	26.1	18.6	KD350	2	116	179	128 X 46 X 95
WD38/120	37.6	29.0	KD440	3	116	205	128 X 53 X 103
WD48/120	48.1	40.2	KD500	3	116	207	128 X 53 X 103

## WESTAIR KOHLER PETROL AIR COMPRESSORS

WP20/70K	20.2	14.7	CH270	3	70	83	94 X 32 X 76
WP27/70K	28.3	22.1	CH395	2	70	87	105 X 40 X 85
WP38/110K	37.6	29.0	CH395	3	110	193	130 X 45 X 97
WP50/160K	52.6	41.4	CH440	3	160	213	150 X 45 X 109



WP14DD



WP20/70



WP27/70

## MARCHANT PNEUMATIC POST DRIVER O/N: 08PD102

The Marchant Pneumatic Post Driver is designed and manufactured in Australia for the harsh Australian Conditions.

It is capable of driving a large array of posts through bitumen, shale and black soil surfaces, as well as ironstone and sandstone. WEIGHT: 18KG

### KIT CONSISTS OF:

- Standard 54mm guide
- Striking dolly in the driver plus a spare striking dolly
- Quick release coupling & hose clamp to connect air hose direct to the driver
- Spare grub screws, lock nuts & allen key



08PD102

PRICES EXCLUDE GST

T: (08) 9362 6811

105

F: (08) 9361 3263



# WESTAIR PORTABLE AIR COMPRESSORS

## MODEL WP27/70

The WP27/70H and WP27/70K offer slow revving high output cast iron pumps with replaceable cartridge element intake air filters on AS1210 70L air receivers with load genie valve and auto engine idle. Factory set at 125psi cutout but adjustable to 145psi if required.

Suitable for a range of tools such as:

- 3/4" drive impact guns
- Small air hammer
- Plasma cutter
- Nail guns
- Grease gun
- Truck tyre inflator
- Medium blow guns
- High/low pressure spray guns

**POWERED by**  
**HONDA™**



WP27/70H



WP27/70K

## KOHLER® Engines



### KEY FEATURES

- Heavy duty slow revving pumps
- AS 1210 air receivers
- Stainless steel reed valves
- Genuine Honda or Kohler petrol engines
- Load genie valve and engine auto idle
- Replaceable cartridge element intake air filters
- Electric start engines with or without battery and leads are available as optional extras (Honda)
- Electric start engines with battery and leads are fitted as standard on the Kohler model

MODEL	DISP CFM	FAD CFM	FAD L/M	MAX PSI	HP	ENGINE	CYL	TANK (L)	WEIGHT (KG)	L x W x H	NOISE LEVEL
WP27/70H	28.3	22.1	625	145	9	GX270	2	68	87	105 X 40 X 85	82
WP27/70K*	28.3	22.1	625	145	9.5	CH395	2	68	87	105 X 40 X 85	82

\* Electric start with battery and leads fitted as standard.

PRICES EXCLUDE GST

T: (08) 9362 6811

106

F: (08) 9361 3263

# AIRSTREAM AIR COMPRESSORS

MODEL	DISP CFM	FAD CFM	FAD L/M	MAX PSI	HP	ELECTRICAL SUPPLY	CYL	TANK (L)	WEIGHT (KG)	L x W x H	NOISE LEVEL
-------	----------	---------	---------	---------	----	-------------------	-----	----------	-------------	-----------	-------------

## SINGLE PHASE DIRECT DRIVE OIL FREE SILENT

AO512	3.0	1.65	47	120	0.73	10 AMP	2	12	16	50 x 22 x 52	58
AO735	5.3	2.5	71	120	1	10 AMP	2	35	25	63 x 37 x 63	58
AO750	10.5	5.0	142	120	2	10 AMP	4	50	74	70 x 40 x 76	58
AO7100	15.8	7.5	212	120	3	10 AMP	6	96	85	110 x 41 x 86	58

## SINGLE PHASE BELT DRIVE

ASE10/50	9.7	6.1	172	120	2.2	10 AMP	2	50	74	70 x 40 x 76	70
ASE12/100	11.5	7.4	210	120	2.2	10 AMP	2	96	85	110 x 41 x 86	75
ASE16/100	15.4	10.6	300	120	3	15 AMP	2	96	85	110 x 41 x 86	75

## 3 PHASE BELT DRIVE 415 VOLT

ASA25/170	27.8	20.2	573	135	5.5	20 AMP	2	170	170	160 x 54 x 98	83
ASA35/170	35.1	24.2	687	135	7.5	20 AMP	3	170	190	160 x 60 x 100	85
ASA45/330	46.5	38.9	1,100	135	10	20 AMP	3	330	260	189 x 76 x 115	85
ASA65/330	62.4	48.0	1,358	135	15	32 AMP	3	330	420	189 x 78 x 126	85

## PETROL POWERED LONCIN ENGINE

AP20/70	19.4	13.2	373	120	505	LC196	3	70	83	94 x 32 x 76	82
AP38/120	39.7	29.5	835	120	14	LC420	3	116	190	128 x 45 x 94	84



AO512



AO735



AO750



AO7100



ASE10/50



ASE16/100

PRICES EXCLUDE GST

T: (08) 9362 6811

107

F: (08) 9361 3263

# WELDERS

## UNIFLAME CUTTING KITS O/N KK0XY1

### KIT INCLUDES :

- |                                 |                                  |
|---------------------------------|----------------------------------|
| 1 x Heavy Duty Tool Box         | 1 x Heating Tip                  |
| 1 x Oxygen Regulator            | 1 x Oxy Welding Goggles          |
| 1 x Acetylene Regulator         | 1 x Tip Cleaners                 |
| 1 x Blowpipe                    | 1 x Flint Lighter                |
| 1 x Cutting Attachment          | 2 x Flashback Arrestors (handle) |
| 1 x Mixer                       | 2 x Flashback Arrestors (regs)   |
| 1 x 10 Metre Twin Gas Hose      | 1 x Combination Spanner          |
| 3 x Welding Tips 8 / 12 / 15    | 1 x Radius Bar & Pivot           |
| 3 x Cutting Nozzles 8 / 12 / 15 | 1 x Roller Guide                 |



## UNIFLAME CUTTING KITS O/N KK0XY2

AS ABOVE except 1 x LPG Regulator (not Acetylene)

ORDER NO	VOLTS	TORCH	EARTH LEAD	REGULATOR	MAX CUT (MM)	WEIGHT (KG)	DIMENSIONS (L x W x H)
<b>UNIMIG PLASMA CUTTERS</b>							
KUPJRV40 Viper Cut	240V	TCBR50 Plasma	3M	YES	10	11.6	460 x 160 x 320
KUPJRRW45 Razor Cut	415V	Uni ARC CBR 150	4M	YES	16	21	540 x 220 x 370
KUPJRRW80 Razor Cut	415V	SC80 Plasma	4M	YES	28	16	560 x 220 x 415



KUPJRV40 Viper Cut



KUPJRRW45 Razor Cut



KUPJRRW80 Razor Cut

ORDER NO	DESCRIPTION	VIEWING AREA	INACTIVE SHADE	ACTIVE SHADE	ORDER NO INNER LENSE	ORDER NO OUTER LENSE
<b>UNIMIG WELDING HELMETS</b>						
UMMBWH	AUTO DARKENING RAZORBACK HELMET	100 X 60MM	4	9 - 13	UMRBIP	UMRBOP
UMVWH	AUTO DARKENING HELMET	96 X 42MM	4	9 - 13	UMIP	UMOP
UMRWWH	AUTO DARKENING HELMET	100 X 60MM	4	9 - 13	UMRBIP	UMRBOP
UMRWXWH	AUTO DARKENING / GRINDING HELMET	110 X 90MM	4	9 - 13	UMLIP	UMLOP



UMMBWH



UMVWH



UMRWWH



UMRWXWH

PRICES EXCLUDE GST



# WELDERS

	SPECIFICATIONS	
<b>KUMJRRW180CA</b>		
<ul style="list-style-type: none"> <li>Arc 170 Amp MMA/ TIG Welding Inverter</li> <li>4m ARC Welding Lead set 35-50mm Dinse style connections</li> <li>PVC carry case</li> <li>Optional TIG Torch 17V-4MCP50</li> <li>35/50 Dinse style connection TIG torch</li> <li>Optional Uni-Flame Flowmeter Argon Regulator.</li> </ul>	PRIMARY INPUT VOLTAGE	240V 1 PHASE
	RATED INPUT POWER	7.7 KVA
	RATED OUTPUT POWER	170A/ 26.8V
	DUTY CYCLE 40 DEG C	25% @ 170 AMPS MMA
	DUTY CYCLE 25 DEG C	100% @ 85 AMPS MMA
	WELDING CURRENT RANGE	10-170A
	WIRE SPOOL SIZE (KG)	NA
	WIRE SIZE (MM)	NA
	DIMENSIONS (MM)	320 X 120 X 210
	WEIGHT (KG)	5.2 KG
<b>KUMJRRW205SSMIG</b>		
<ul style="list-style-type: none"> <li>Uni-Mig 190 Multifunction Welding Inverter</li> <li>SB244M Unimig Sure Grip Ergo Mig Torch With Euro connection</li> <li>4M ARC Welding lead set 10-25mm dinse style connections</li> <li>Uni-Flame Twin Gauge Argon Regulator</li> <li>2M Gas Hose Complete with fittings</li> <li>Optional TIG Torch 17V-4MCP25 10/25 Dinse style connection TIG torch.</li> </ul>	PRIMARY INPUT VOLTAGE	240V 1 PHASE
	WELDING CURRENT MIG	30-190 AMPS
	VOLTAGE STEPS	10-160 AMPS
	DUTY CYCLE 40 DEG C - MIG	35% @175A / 100% @103A
	DUTY CYCLE 40 DEG C - MMA	35% @ 160A / 100% @95A
	WELDING VOLTAGE RANGE DC	15.5V - 23V
	WIRE SPOOL SIZE (KG)	1 KG & 5 KG
	WIRE SIZE (MM)	0.9-1.0 ALUMINIUM 0.9-1.2 FLUX CORED
	DIMENSIONS (MM)	480 X 230 X 360
	WEIGHT (KG)	19 KG
<b>KUMJRRW200MIG</b>		
<ul style="list-style-type: none"> <li>RAZORWELD 200 Welding Inverter</li> <li>SB244M Unimig Sure Grip Ergo Mig Torch with Euro connection</li> <li>Uni-Flame Twin Gauge Argon Regulator</li> <li>2M Gas Hose Complete with fittings</li> <li>10 metre ARC Welding Lead Set</li> <li>Trolley including tool draw</li> </ul>	PRIMARY INPUT VOLTAGE	240V 1 PHASE
	WELDING CURRENT MIG	20-250 AMPS
	VOLTAGE STEPS	10-250 AMPS
	DUTY CYCLE 40 DEG C - MIG	20% @200A
	DUTY CYCLE 40 DEG C - MMA	15% @ 200A
	WELDING VOLTAGE RANGE DC	11V - 29V
	WIRE SPOOL SIZE (KG)	1 KG & 5 KG
	WIRE SIZE (MM)	0.9-1.2 ALUMINIUM 0.9-1.2 FLUX CORED
	DIMENSIONS (MM)	470 X 190 X 380
	WEIGHT (KG)	12.5 KG
<b>KUMJR250</b>		
<ul style="list-style-type: none"> <li>Uni-Mig 250 Multifunction Inverter Welder</li> <li>SB244M Unimig Sure Grip Ergo Mig Torch with Euro connection</li> <li>Uni-Flame Twin Gauge Argon Regulator</li> <li>2M Gas Hose Complete with fittings</li> <li>4 metre ARC Welding Lead Set</li> <li>Optional Trolley UMJRTROLLEY3</li> </ul>	PRIMARY INPUT VOLTAGE	240V 1 PHASE
	WELDING CURRENT MIG	30-250 AMPS
	VOLTAGE STEPS	10-250 AMPS
	DUTY CYCLE 40 DEG C - MIG	35% @250A/100% @148A
	DUTY CYCLE 40 DEG C - MMA	35% @ 224A / 100% @137A
	WELDING VOLTAGE RANGE DC	15.5V - 22.5V
	WIRE SPOOL SIZE (KG)	5 & 15 KG
	WIRE SIZE (MM)	0.9-1.2 ALUMINIUM 0.9-1.2 FLUX CORED
	DIMENSIONS (MM)	580 X 230 X 450
	WEIGHT (KG)	24 KG



PRICES EXCLUDE GST

# WELDERS

	SPECIFICATIONS	
<b>KUMJR250SWF</b>		
<ul style="list-style-type: none"> <li>• Uni-Mig 250 SWF Multifunction Welding Inverter Complete with Separate Wire Feeder</li> <li>• 10 Metre Inter Connecting Cables</li> <li>• SB244M Unimig Sure Grip Ergo Mig Torch With Euro connection</li> <li>• Uni-Flame Twin Gauge Argon Regulator</li> <li>• 2M Gas Hose Complete with fittings</li> <li>• 10 metre ARC Welding Lead Set</li> <li>• Trolley including tool draw</li> </ul>	PRIMARY INPUT VOLTAGE	240V 1 PHASE
	WELDING CURRENT MIG	20-250 AMPS
	VOLTAGE STEPS	10-250 AMPS
	DUTY CYCLE 40 DEG C - MIG	35% @250A 100% @148A
	DUTY CYCLE 40 DEG C - MMA	35% @ 240A / 100% @137A
	WELDING VOLTAGE RANGE DC	11V - 29V
	WIRE SPOOL SIZE (KG)	5 & 15 KG
	WIRE SIZE (MM)	0.9 - 1.2 ALUMINIUM 0.9 - 1.2 FLUX CORED
	DIMENSIONS (MM)	1275 X 800 X 475
	WEIGHT (KG)	90 KG
<b>KUM270SWF</b>		
<ul style="list-style-type: none"> <li>• Uni-Mig 270 SWF Mig Welder</li> <li>• KT 50 Separate Wire Feeder complete with 10 metre interconnecting cables</li> <li>• SB244M Unimig Sure Grip Ergo Mig Torch with Euro connection</li> <li>• Uni-Flame Twin Gauge Argon Regulator</li> <li>• 2M Gas Hose Complete with fittings</li> <li>• 10 metre Earth lead with 35/50 Dinse style connections.</li> </ul>	PRIMARY INPUT VOLTAGE	240V 1 PHASE
	WELDING CURRENT MIG	30-250 AMPS
	VOLTAGE STEPS	21
	DUTY CYCLE 40 DEG C - MIG	70% @250A
	DUTY CYCLE 40 DEG C - MMA	100% @210A
	WELDING VOLTAGE RANGE DC	14V - 26V
	WIRE SPOOL SIZE (KG)	5 & 15 KG
	WIRE SIZE (MM)	0.9 - 1.2 ALUMINIUM 0.9 - 1.2 FLUX CORED
	DIMENSIONS (MM)	1270 X 880 X 475
	WEIGHT (KG)	139 KG
<b>KUM390SDSWF</b>		
<ul style="list-style-type: none"> <li>• Mig 390 S/D SWF Multifunction Welding Inverter complete with Separate Wire Feeder</li> <li>• Dual Voltage 415V 3 Phase or 480V Single phase (Rural Welder)</li> <li>• 10 Metre Inter Connecting Cables</li> <li>• SB364M Unimig Sure Grip Ergo Mig Torch with Euro connection</li> <li>• Uni-Flame Twin Gauge Argon Regulator</li> <li>• 2M Gas Hose Complete with fittings</li> </ul>	PRIMARY INPUT VOLTAGE	480V 2 PHASE
	WELDING CURRENT MIG	40-375 AMPS
	VOLTAGE STEPS	30
	DUTY CYCLE 40 DEG C - MIG	70% @355A
	DUTY CYCLE 40 DEG C - MMA	100% @300A
	WELDING VOLTAGE RANGE DC	16-32.5V
	WIRE SPOOL SIZE (KG)	5 & 15 KG
	WIRE SIZE (MM)	0.9 - 1.2 ALUMINIUM 0.9 - 2.4 FLUX CORED
	DIMENSIONS (MM)	1270 X 940 X 600
	WEIGHT (KG)	199 KG
<b>KUM500SWF</b>		
<ul style="list-style-type: none"> <li>• Uni-Mig 500 SWF Mig Welder</li> <li>• KT 90 Separate Wire Feeder complete with 10m interconnecting cables</li> <li>• TWC5-15FTE Sure Grip Ergo Mig Torch with Euro connections</li> <li>• 10m Earth lead with 35/50mm Dinse Style connections</li> <li>• Uni-Flame Twin Gauge Argon Regulator</li> <li>• 2m Gas Hose Complete with fittings</li> </ul>	PRIMARY INPUT VOLTAGE	415V 3 PHASE
	WELDING CURRENT MIG	50-450 AMPS
	VOLTAGE STEPS	50
	DUTY CYCLE 40 DEG 35%	450 AMPS
	DUTY CYCLE 40 DEG 100%	320 AMPS
	WELDING VOLTAGE RANGE DC	16-36V
	WIRE SPOOL SIZE (KG)	5 & 15 KG
	WIRE SIZE (MM)	0.9 - 1.2 ALUMINIUM 0.9 - 1.2 FLUX CORED
	DIMENSIONS (MM)	1270 X 940 X 600
	WEIGHT (KG)	199 KG



PRICES EXCLUDE GST

T: (08) 9362 6811

110

F: (08) 9361 3263



# WINCHES

PART NO	CATEGORY	VOLTS	RATING	DESCRIPTION	WIRE SIZE	WEIGHT
AL01572	BRAKE WINCH	NA	1500 LBS	WINCH AND CABLE COMPLETE WITH SAFETY HOOK		3.2 KG
AL01576	BRAKE WINCH	NA	2000 LBS	WINCH AND CABLE COMPLETE WITH SAFETY HOOK		6.8 KG
AL01577	BRAKE WINCH	NA	3500 LBS	WINCH AND CABLE COMPLETE WITH SAFETY HOOK		
AL02637	HAND WINCH	NA	440 LBS	HAND WINCH TWO WAY RATCHET		2.73 KG
AL01646	HAND WINCH	NA	900 LBS	HAND WINCH COMPLETE WITH CABLE AND SAFETY HOOK		2.4 KG
AL01633	HAND WINCH	NA	1200 LBS	HAND WINCH ONE WAY RATCHET FREE SPOOL IN OFF POSITION		3.0 KG
AL01637	HAND WINCH	NA	2000 LBS	HAND WINCH ONE WAY RATCHET FREE SPOOL IN OFF POSITION		6.0 KG
AL01511	TWO SPEED	NA	2500 LBS	HAND WINCH TWO SPEED SUPPLIED WITH CABLE AND SAFETY HOOK		6.4 KG
AL01624	ELECTRIC	12V	4000 LBS	ELECTRIC WINCH 2 HP	5.56MM	9 KG
AL01626	ELECTRIC	12V	6000 LBS	ELECTRIC WINCH 3.6 HP	7.94MM	31.8 KG
AL01629	ELECTRIC	12V	9500 LBS	ELECTRIC WINCH 4.5 HP	9.52MM	37 KG
AL02685	ELECTRIC	12V	12000 LBS	ELECTRIC WINCH 4.8 HP	9.52MM	43 KG
AL01675	ELECTRIC	12V	15000 LBS	ELECTRIC WINCH 7.3 HP	10MM	46 KG
AL01676	ELECTRIC	24V	15000 LBS	ELECTRIC WINCH 7.3 HP	10MM	46 KG
AL01680	HYDRAULIC	NA	9000 LBS	HYDRAULIC WINCH 80.6 cm <sup>3</sup> / REV	9.52MM	44 KG
AL01684	HYDRAULIC	NA	18000 LBS	HYDRAULIC WINCH	12.7MM	51 KG



PRICES EXCLUDE GST

T: (08) 9362 6811

111

F: (08) 9361 3263

# SNATCH STRAPS

## VEHICLE RECOVERY SNATCH STRAP

- Easy to handle and store
- Rot and mildew resistant
- Standard length 9M, other lengths made to order
- 20-30% stretch
- 100% nylon
- Ratings are break strengths
- Snatch strap rating should be 2-3 times vehicle GVM
- Anti recoil straps fitted for added safety
- 62T, 85T & 100T have protective sleeve over full length



ORDER NO	RATING	WEBBING	STANDARD LENGTH
<b>POLYESTER TOW ROPES</b>			
TS30T	30,000KG	FLAT WEB	9 METRE
TS60T	60,000KG	FLAT WEB	9 METRE
TS80T	80,000KG	FLAT WEB	9 METRE
TS105T	105,000KG	ROUND WEB	9 METRE
TS210T	210,000KG	ROUND WEB	9 METRE
TS300T	300,000KG	ROUND WEB	9 METRE
TS350T	350,000KG	ROUND WEB	9 METRE
TS400T	400,000KG	ROUND WEB	9 METRE
TS450T	450,000KG	ROUND WEB	9 METRE

ORDER NO	RATING	WEBBING	STANDARD LENGTH	WEIGHT
<b>NYLON SNATCH STRAPS</b>				
SN8.5T	8,500KG	60MM/1PLY	9 METRE	2.45KG
SN11.5T	11,500KG	75MM/1PLY	9 METRE	2.95KG
SN16T	16,000KG	60MM/2PLY	9 METRE	4.3KG
SN26T	26,000KG	75MM/2PLY	9 METRE	5.1KG
SN32T	32,000KG	100MM/2PLY	9 METRE	7.35KG
SN50T	50,000KG	150MM/2PLY	9 METRE	11.1KG
SN62T	62,000KG	100MM/4PLY	9 METRE	16.8KG
SN85T	85,000KG	150MM/4PLY	9 METRE	22KG
SN100T	100,000KG	60MM/1PLY	9 METRE	29KG
SN150T	150,000KG	60MM/1PLY	9 METRE	36KG

PRICES EXCLUDE GST

T: (08) 9362 6811

112

F: (08) 9361 3263

# LED WORKLIGHTS

ORDER NO	VOLT	WATTS	LEDS	LENS	GLOBE	LUMENS
<b>WORKLAMP LED</b>						
LED621	9-36	5	5	FLOOD	6000K	
LED632	9-36	3	24	FLOOD	6000K	
LED614	9-36	3	80	FLOOD	6000K	14,400
LED615	9-36	3	100	FLOOD	6000K	18,000
LED821	10-30	3	16	FLOOD	6000K	2,880
LED842	10-30	3	9	FLOOD	6000K	2,160
LED861	9-50	10	1	SPOT	6000K	800
LED862	9-50	10	1	FLOOD	6000K	800



DRILL RIG WITH LED621 LIGHTS ON MAST



LED615



LED862



LED821



LED632



LIGHT BAR LED615 FITTED TO STIEGER



LED621



LED842



HID KIT + RALLEY 4000 FITTED TO JD HEADER



LIGHT BAR LED615 JOHN DEERE HEADER

PRICES EXCLUDE GST

T: (08) 9362 6811

113

F: (08) 9361 3263



# CAMERA KITS

ORDER NO	VOLTAGE	DESCRIPTION
<b>CAMERA KITS</b>		
AGCMK3	12 VOLT	7" TFT TOUCH SCREEN LCD DIGITAL REAR VIEW MONITOR, 22PIN, SUITS UP TO 4 CAMERA INPUTS SUPPLIED WITH 2 X 120 DEGREE CAMERA/CABLE
<b>MONITOR SCREEN ONLY</b>		
AGCMM700	12 VOLT	7" TFT TOUCH SCREEN LCD DIGITAL REAR VIEW MONITOR, 22PIN, SUITS UP TO 4 CAMERA INPUTS
<b>CAMERA'S AND ACCESSORIES</b>		
AGCMC120	12 VOLT	1/4" CCD COLOR CAMERA WITH AUDIO AND IR, PAL, 120°, MIRROR IMAGE, 4PIN DIN, BLACK
AGCMAMP	12 VOLT	4-CH COLOR MULTIPLEXER IS NEEDED IF YOU WANT TO VIEW UP TO 4 CAMERAS ON THE SCREEN AT THE SAME TIME
AGCMAC5	NA	5M 4PIN EXTENSION CABLE
AGCMAC10	NA	10M 4PIN EXTENSION CABLE
AGCMAC15	NA	15M 4PIN EXTENSION CABLE
AGCMAC20	NA	20M 4PIN EXTENSION CABLE
AGCMAC16	NA	1.6M TRAILER CABLE CONNECTS TWO CAMERAS INTO ONE CABLE
<b>CAMERA WIRELESS KITS</b>		
AGCMWK1	12/24/36	7" INCH TFT LCD COLOUR SCREEN AV INPUT AND INPUT FOR 2 CAMERA'S WIRELESS, WATER PROOF DAY/NIGHT CAMERA CABLE AND ANTENNA'S SUPPLIED
AGCMWC80	12	WIRELESS WATERPROOF CAMERA



## SECURITY CAMERA KITS \*\*\*\*NEW ITEM \*\*\*\*

This camera has been specifically designed as a black flash camera from the ground up. Unlike other infra-red cameras there is no red glow when it records photo or video making it great for getting in close without risking it being seen. We have been very impressed with the image quality, sensitivity, and battery life of this camera.

In dark night situations the Black Flash cameras have an incredible advantage over regular infra-red cameras in that the chances of the camera being seen by both people and animals are more remote. These are widely used for use in sheds and on machinery and for monitoring wildlife without spooking the target.

### VH200HD - 12 VOLT

### VH200HD-P - 12 VOLT

- **Infra-red Black flash that cannot be seen.** The infra-red black flash does not give off any light at night.
- **Very good battery life.** Runs on 12 AA lithium or rechargeable batteries. 10000 plus images from lithium batteries.
- **HD Video Quality.** Makes it easier to make out details in the video footage.
- **Excellent image quality with improved night time images.** Colour during the day and B&W at night.
- **Built in image viewer with easy to use menu for camera set up.** Open up the camera to find the built in image viewer. Very easy to use menu system.
- **Weather-proof clamshell case** - camo or grey.
- **Small compact size.** 10cm wide x 14.9cm high x 5.5cm.
- **Can record sound in video mode.**



VH200H



PRICES EXCLUDE GST

T: (08) 9362 6811

114

F: (08) 9361 3263

# MOBILE SMART PHONE CAR KITS



Boost signal reception significantly with these easy to install professionally built car kit cradles from Strike.

## Features:

- Integrate seamlessly - with the cradle being fully pass through compatible, Strike has allowed your Alpha Cradle to be used with any Bluetooth car kit, entertainment unit or your computer.
- Holds, charges, protects and boosts the signal of your phone.
- Accepts 12/24 volt charging with voltage spike protection.
- Up to 2Amps output. The FASTEST phone charger in the world.
- Engineered to ensure the handset sits flush against the passive antenna connection. Providing superior signal boosting performance.
- The internal passive antenna booster is specifically tuned for Australian networks including Telstra next G and all 4G. Comes with FME male for external antenna connection.
- Designed, engineered and made in Australia for Australian conditions.
- 3 Year warranty.

## B2 7 dBi HEAVY DUTY BULL BAR MOUNT ANTENNA.

Frequency 3G 2100Mhz and 850Mhz  
 Antenna length 730 mm  
 Cable length 4 m  
 Solid spring mount for bull bar.  
 Weight 1.1kg

7 DB ANTENNA



This is a high performance antenna for use where coverage is essential. The multiband design of the Strike B2 7dBi Heavy Duty Bull Mount Antenna sets this antenna apart from others.

It has been especially designed to provide maximum range and performance. This antenna's high gain and reliable performance over GSM. 850/900/1800/1900/2100MHz frequencies makes it ideal for rural areas. This antenna has a removable whip and comes fitted with an FME connector and a bull bar mounting bracket which makes the installation quick and easy. The removable whip allows for seamless removal and re-attachment as the user desires. This antenna whip is black. Works with all Australian networks.



IPHONE 5 & 5S



IPHONE 4



BLACKBERRY 9700



SAMSUNG S4

ORDER NO	DESCRIPTION
<b>CRADLES</b>	
UNIVERSAL	DIY OR PROFESSIONAL FIT
STKSTSCIP5	IPHONE 5 CRADLE
STKSTSCIP6	IPHONE 6 CRADLE
STKSTSCIP7	IPHONE 7 CRADLE
STKSTSC9700	BLACKBERRY 9700 CRADLE
STKSTSCS7	SAMSUNG GALAXY S7
<b>OPTIONS</b>	
STKB1	ANTENNA 7 DB SUPPLIED WITH MOUNTING BRACKET
ACCSTKTR	STRIKE TR SUCTION MOUNT

\*\*\*\*OTHER KITS AVAILABLE ON REQUEST \*\*\*\*

PRICES EXCLUDE GST

T: (08) 9362 6811

115

F: (08) 9361 3263



# CHAMBERLAIN TRACTORS

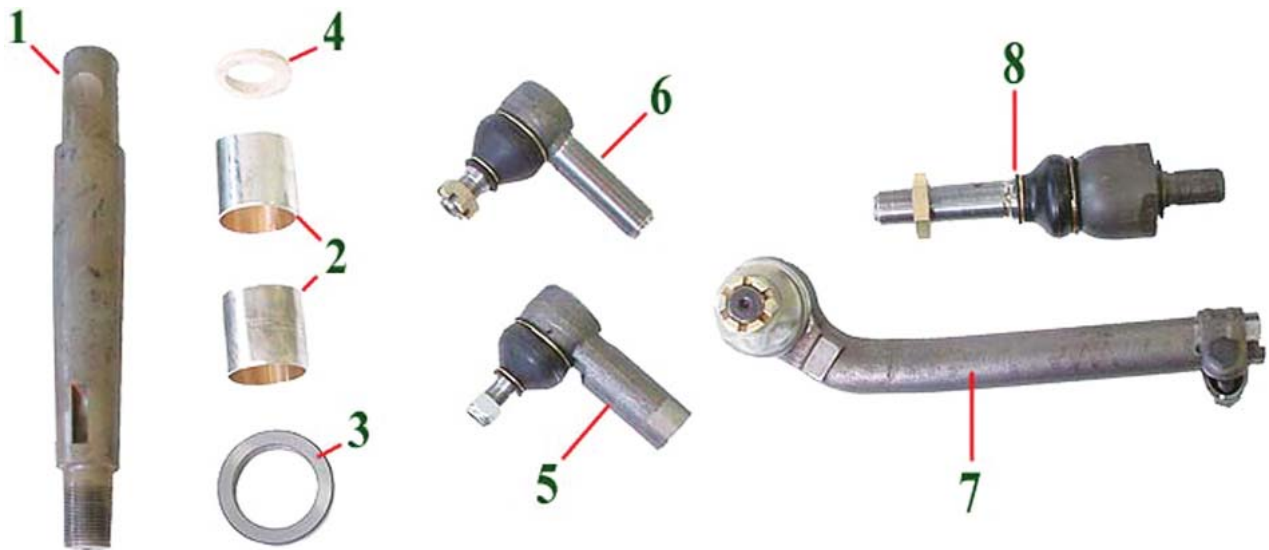

REF	PART NO	DESCRIPTION	APPLICATION
1	CHAM60296	Spindle (King Pin) 324mm long (confirm length)	Champion 236, 306, Countryman 306, (Countryman 354, C670 with fixed width front axle), 3380 fitted with original type 2 piece stub axle
	CHAM61071	Spindle (King Pin) 353mm long (confirm length)	4080, 4080B, 4280 fitted with original type 2 piece stub axle
2	CHAM60667	Bush	Champion 236, 306, MKIII, C6100, Countryman 306, 354, C670, 3380, 4080, 4280, 4480, 4290, 4490, 4690
3	CHAM37092	Thrust Bearing	
4	CHAM69596	Seal	
5	CHAM70728	Female End 1" dia LH thread	
	CHAM70727	Female End 1" dia RH thread	
6	CHAM56858	Male End 1" dia LH thread	Models with fixed Axle Width: 3380, 4080, 4280, 4480, 4090, 4290, 4690 Models with Adjustable Width Axle: use B4671 on RH side only
	CHAM56782	Male End 1" dia RH thread	
7	AL39315	LH Outer End	4090 Four Wheel Drive
	AL39318	RH Outer End	
8	AL39316	Inner End	



PART NO	DESCRIPTION	SUITS
CHAM64481	HUB FRONT AXLE	3380, 4080, 4280, 4090, 4290, 4490, 4960

PRICES EXCLUDE GST

T: (08) 9362 6811

116

F: (08) 9361 3263

# SERVICE

## DID YOU KNOW...

- Agriparts has an extensive workshop.
- Whether it's lathe work, milling or gear cutting... we have the capabilities.

We are also the authorised Comer Industries service centre for all Comer Industries Gearboxes, PTO Shafts and Planetarys.



PRICES EXCLUDE GST

T: (08) 9362 6811

117

F: (08) 9361 3263





# AGRIPARTS & REPAIRS

29 WELSHPOOL ROAD, WELSHPOOL WA 6106

[sales@agriparts.com.au](mailto:sales@agriparts.com.au)

PH: + 61 (8) 9362 6811    FAX: +61 (8) 9361 3263

[www.agriparts.com.au](http://www.agriparts.com.au)